

DKM-Motoren

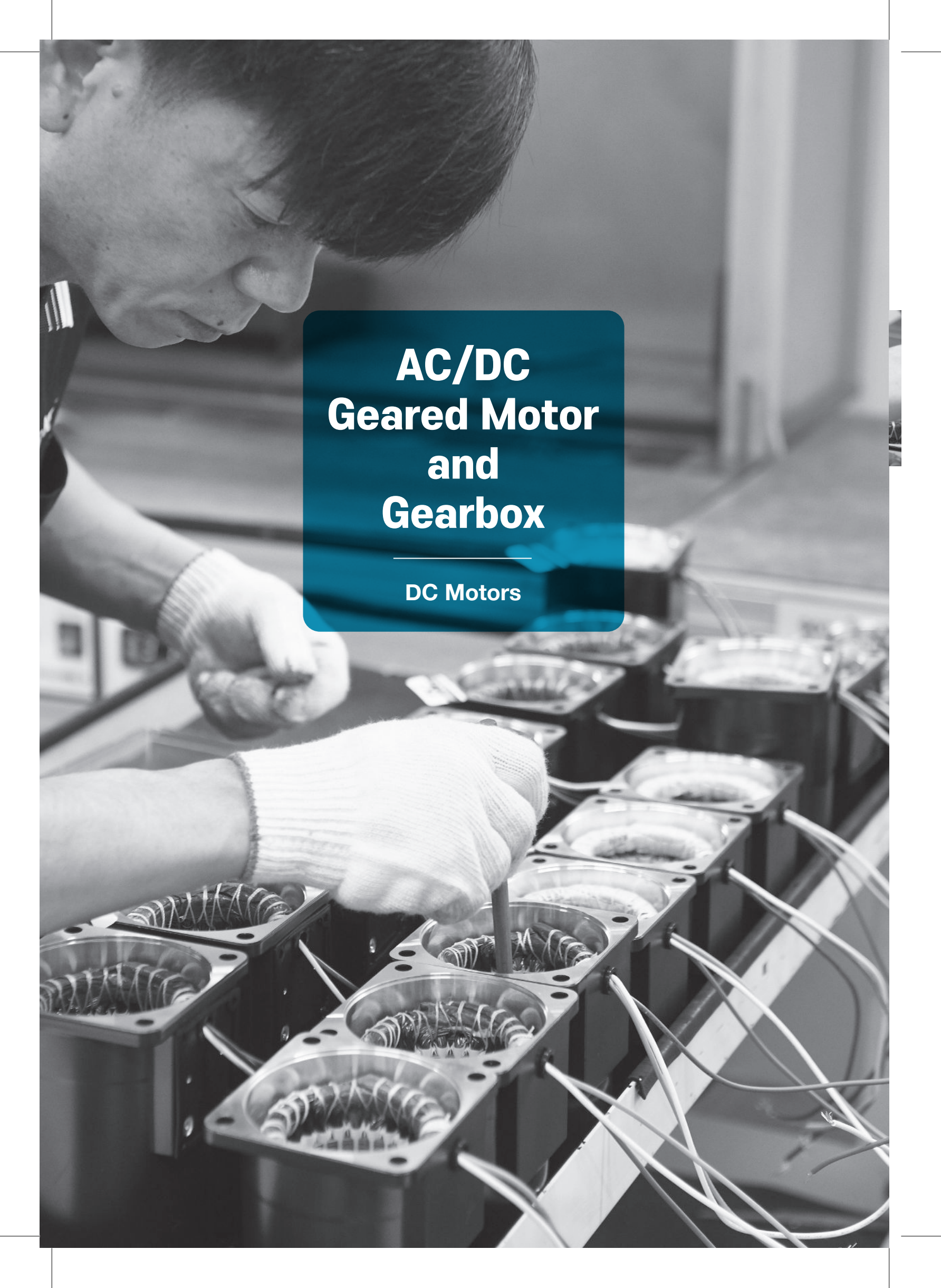



AC/DC Geared Motor and Gearbox

DC Motors



A Information

- A-01 Product Coding System
- A-04 Product Lineup
- A-09 Combination table
- A-13 General Information
- A-17 Terminology
- A-20 Caution for Use

B AC Motors

- B-01 Technical Data of AC Motor
- B-06 Induction Motor
- B-58 2 Pole Motor
- B-76 Reversible Motor
- B-112 Brake Motor
- B-162 Clutch & Brake Motor
- B-178 Torque Motor
- B-206 Speed Control System
 - B-209 Speed Controller FX3000
 - B-213 Speed Controller DX3000
 - B-217 Speed Controller DSA
 - B-219 Speed Controller DSKM
 - B-224 Speed Control Induction Motor
 - B-258 Speed Control Reversible Motor
 - B-288 Speed Control Brake Motor
 - B-322 Speed Control Clutch & Brake Motor
- B-336 DSY Series

C DC Motors

- C-01 Technical Data of DC Motor
- C-04 DC Motor
- C-20 Speed Controller DSD-90

D Gearboxes

- D-01 Technical Data of Gearbox
- D-07 Parallel Gearbox
- D-13 Right-Angle Gearbox
- D-18 Inter-decimal Gearbox

E Options

- E-01 Mounting Bracket
- E-03 Extension Cable
- E-04 Output Flange / Output Shaft

C DC Motors

Technical Data of DC Motor

Features

- DC motor has a big starting torque and excellent mobility and when comparing with the same sized AC motor, the output is big and the efficiency is high.
- It is easy to control the speed and change the normal/reverse rotation.
- Compared to AC motor, it is available to manufacture low voltage motor which can be applied to portable machine which uses various spec., especially battery power (12V, 24V).
- Due to the wear of brush, there is a limit in the service life.
- The brush and commutator could cause noise when DC motor operates.

Current, Torque and Speed (r/min)

When the voltage of the power supply is fixed, the D.C. magnet motor shows the characteristic in the relationship between torque, speed, and current as below. As shown in the figure below they are almost linear relationships. If you increase the torque on the output shaft of the motor, proportional to that, the rotational speed decreases, and the current increases inversely. If the heating of the motor is ignored, it is the same until the output shaft of the motor is done a stall. (It is possible to control the torque by controlling the current.)

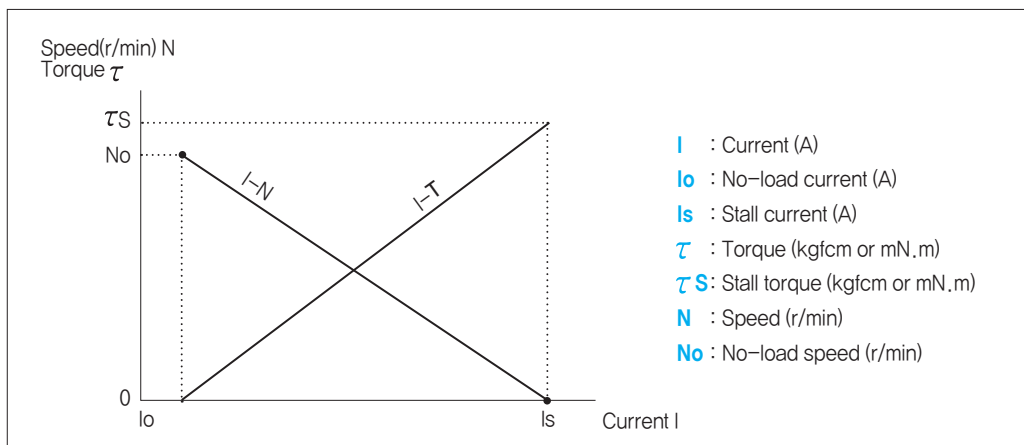

Rating Time

According to increase of current (torque), heat generation in the motor increases. If the temperature of components is saturated within the operating temperature range, it is possible to keep continuous operation.

If it is not saturated within the operating temperature, the time until it exceeds the operating temperature becomes the rated time and is classified as the motor of the short-time rated specification.

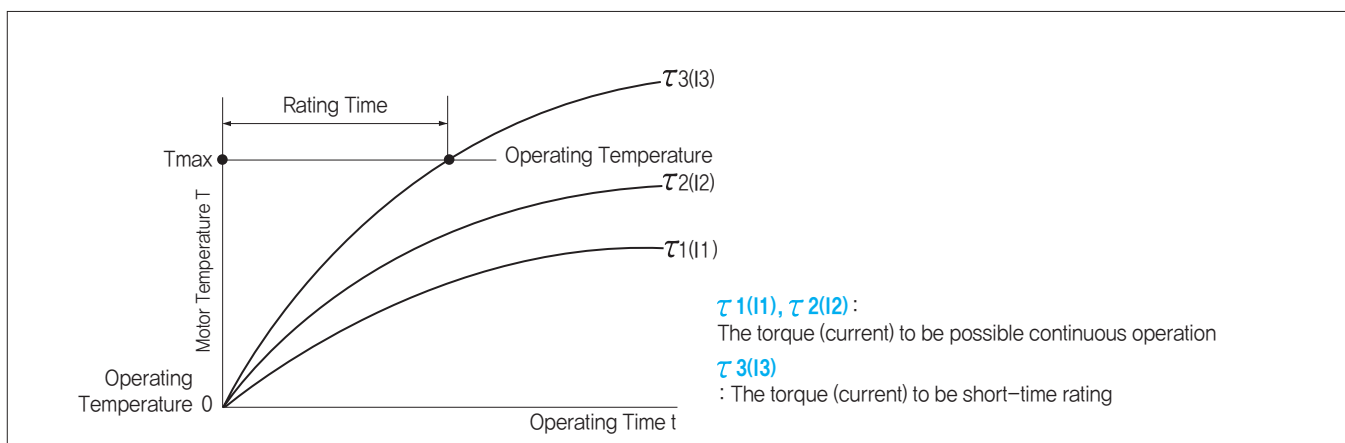

Performance of DC Motor in Case of Voltage Change at Power Supply

DC magnet motor can change speed by changing the power supply voltage. The relationship between torque(τ), speed(N) and current(I) of a motor when the voltage is half (1/2) is shown below.

As the below figure, in the relationship between current and speed when power supply voltage was changed to half (1/2), ideal no-load speed "Nt" becomes "Nt/2" and it falls parallel to the performance of rated voltage.

The relationship between current and torque is the same as the rated voltage, but the stall torque " τ_s " falls accordingly as the stall current " I_s " becomes " $I_s/2$ ".

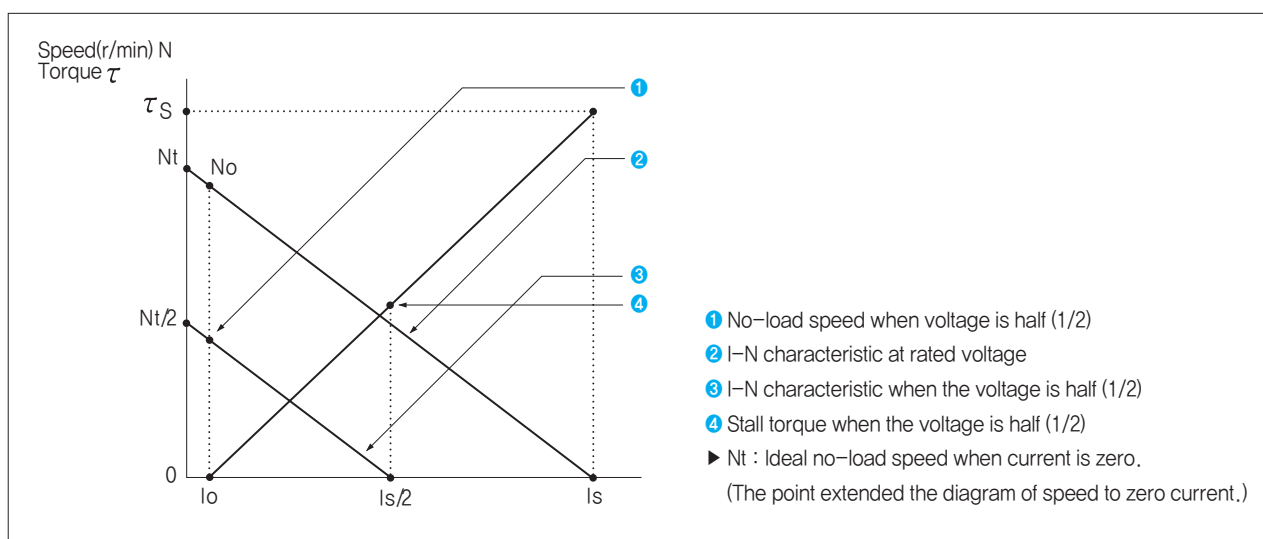

Input, Output and Efficiency of DC motor

The input, output and efficiency can be calculated with the next formula.

$$\begin{aligned} \text{Input(W)} &= \text{Power Supply Voltage(V)} \times \text{Current I(A)} \\ \text{Output(W)} &= \text{Torque } \tau \text{ (kgfcm)} \times \text{Speed N(r/min)} \times 1.027 \times 10^{-2} \\ \text{Efficiency } \eta \text{ (\%)} &= \frac{\text{Output(W)}}{\text{Input(W)}} \times 100 \end{aligned}$$

General Specifications

Item	Specification
Insulation Resistance	100M Ω or more when DC500V MEGA is applied between the windings and the frame after rated motor operation under normal ambient temperature and humidity.
Dielectric Strength	Sufficient to withstand 1.5KV at 50Hz and 60Hz applied between the windings and the frame for 1 minute after rated motor operation under normal ambient temperature and humidity.
Temperature Rise	Temperature rise of windings are 80°C or less measured by the resistance change method after rated motor operation with connecting a gearbox or equivalent heat radiation plate.
Insulation Class	Class B [130°C]
Ambient Temperature	-10°C~+40°C
Ambient Humidity	85% maximum

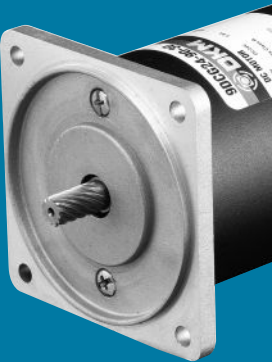

DC Motor



DC Motor

Index

DC Motor 15W (□ 60mm)	C-05
DC Motor 25W (□ 80mm)	C-07
DC Motor 40W (□ 80mm)	C-09
DC Motor 60W (□ 90mm)	C-11
DC Motor 90W (□ 90mm)	C-13
DC Motor 120W (□ 90mm)	C-15
DC Motor 200W (□ 90mm)	C-17
DSD-90	C-20

C DC Motors

DC Motor 15W(□ 60mm)

15W DC Motor 15W(□ 60mm)

Motor Specification

Model 6DCG*-15-30: Gear Type Shaft 6DCD*-15-30: D-Cut Type Shaft	Output W	Voltage V	No Load		Starting Torque		Starting Current A	Rated Load			
			Speed r/min	Current A	kgfcm	N.m		Speed r/min	Current A	Torque kgfcm N.m	
6DC □ 12-15-30	15	12	3200	1.00	4.20	0.420	13.00	3000	1.90	0.49	0.049
6DC □ 24-15-30	15	24	3500	0.40	4.20	0.420	7.50	3000	1.10	0.49	0.049
6DC □ 90-15-30	15	90	3150	0.10	4.80	0.480	2.60	3000	0.25	0.49	0.049

- 1) Enter the voltage code in the place * and enter the output shaft type in the box (□) within the motor model name.
2) Gear Type Shaft is for attaching a gearbox and D-Cut Type Shaft is for using the motor only.

Performance Curve

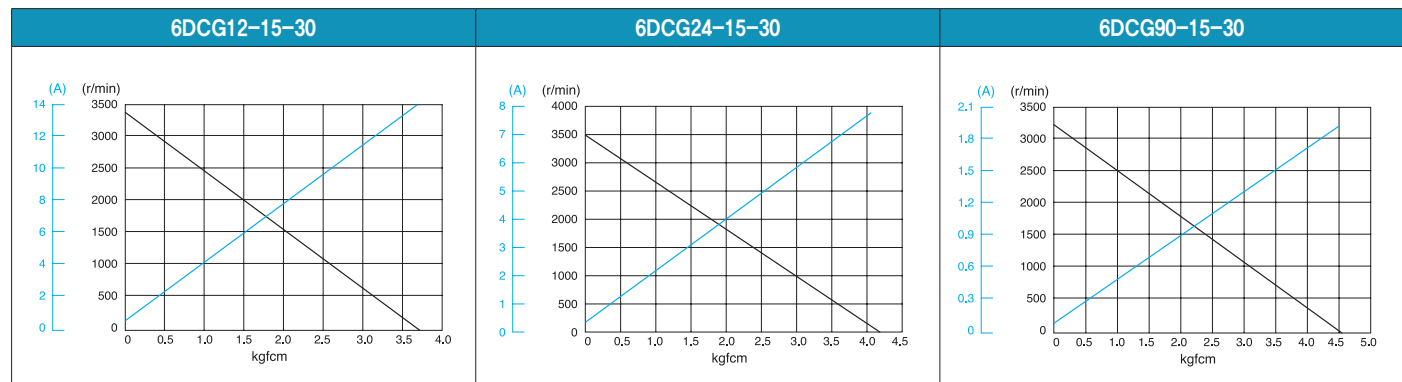

Max. Permissible Torque at Output Shaft of Gearbox

Motor Model	Gearbox Model	Gear Ratio r/min	3	3.6	5	6	7.5	9	10	12.5	15	18	20	25	30	36	40	50	60	75	90	100	120	150	180	200	250	
6DCG*-15-30	6GBD □ MH	kgfcm	1.2	1.4	2.0	2.4	3.0	3.6	4.0	5.0	6.0	7.1	7.2	8.9	10.7	12.9	14.3	16.2	19.4	24.3	29.1	30.0	30.0	30.0	30.0	30.0	30.0	30.0
		N.m	0.12	0.14	0.19	0.23	0.29	0.35	0.39	0.49	0.58	0.70	0.70	0.88	1.05	1.26	1.40	1.58	1.90	2.38	2.85	2.94	2.94	2.94	2.94	2.94	2.94	2.94

- 1) Enter the voltage code in the place * within the motor model name. 2) Enter the gear ratio in the box (□) within the gearbox model name.
3) A colored background indicates the gear shaft rotation in the same direction as the motor shaft; a white background indicates the rotation in the opposite direction.
4) The rotating speed is calculated by dividing the motor's synchronous speed (50Hz: 1,500r/min, 60Hz: 1,800r/min) by the gear ratio. The actual speed is 2~20% less than the displayed value, depending on the size of the load.

Dimensions

MOTOR ONLY

● MOTOR MODEL: 6DCD□-15-30

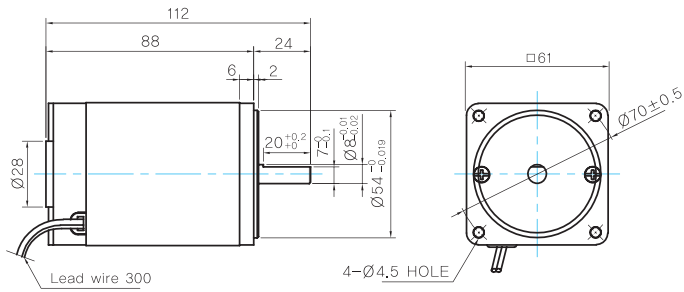

MOTOR OUTPUT SHAFT

MODEL	SPEC
D-CUT TYPE	

GEARED MOTOR

G TYPE GEARBOX

● MOTOR MODEL:
6DCG□-15-30

● GEARBOX MODEL:
6GBD□MH

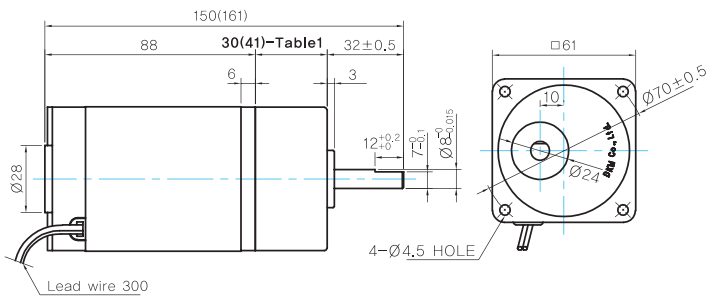

GEARBOX OUTPUT SHAFT

MODEL	SPEC
D-CUT TYPE	

WEIGHT

PART	WEIGHT(Kg)	
MOTOR	0,7	
GEAR BOX	6GBD3MH ~ 6GBD18MH	0,3
	6GBD20MH ~ 6GBD40MH	0,32
	6GBD50MH ~ 6GBD250MH	0,34

30(41)-Table1

SIZE(mm)	GEAR RATIO
30	6GBD3MH - 6GBD18MH
41	6GBD20MH - 6GBD250MH

Motor Images

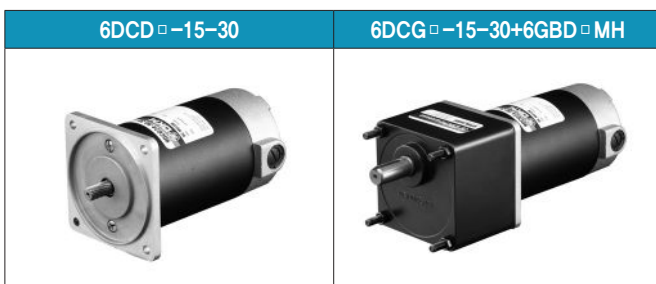

C DC Motors

DC Motor 25W(□ 80mm)

25W DC Motor 25W(□ 80mm)

Motor Specification

Model 8DCG(W)*-25-30: Gear Type Shaft 8DCD*-25-30: D-Cut Type Shaft	Output W	Voltage V	No Load		Starting Torque		Starting Current A	Rated Load			
			Speed r/min	Current A	kgfcm	N.m		Speed r/min	Current A	Torque kgfcm N.m	
8DC □ 12-25-30	25	12	3300	2.00	16.00	1.600	47.00	3000	3.80	0.811	0.081
8DC □ 24-25-30	25	24	3100	0.72	15.00	1.500	22.00	3000	1.50	0.811	0.081
8DC □ 90-25-30	25	90	3150	0.20	21.80	2.180	9.60	3000	0.35	0.811	0.081

- 1) Enter the voltage code in the place * and enter the output shaft type in the box (□) within the motor model name.
2) Gear Type Shaft is for attaching a gearbox and D-Cut Type Shaft is for using the motor only.

Performance Curve

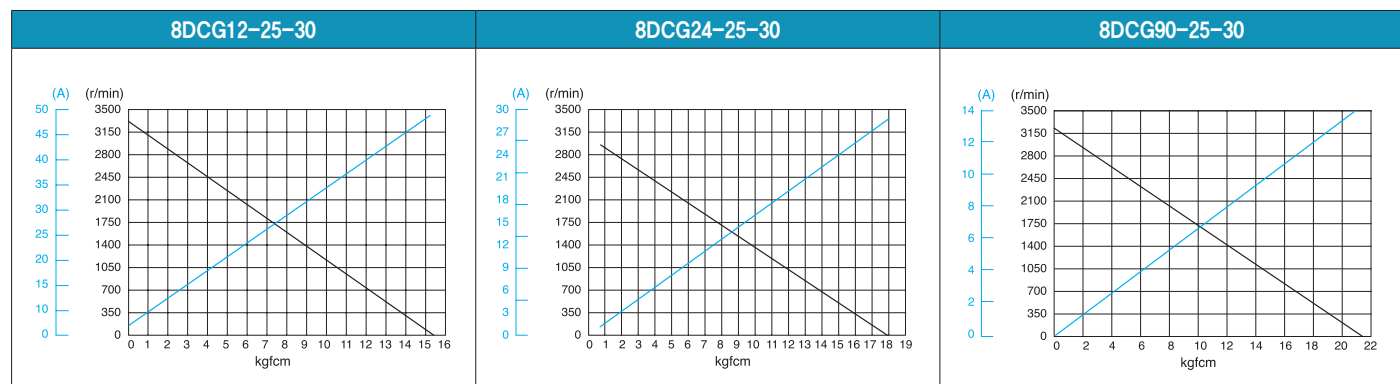

Max. Permissible Torque at Output Shaft of Gearbox

Motor Model	Gearbox Model	Gear Ratio r/min	3	3.6	5	6	7.5	9	10	12.5	15	18	20	25	30
			8DCG*-25-30	8GBK □ BMH	kgfcm N.m	2.0 0.19	2.4 0.23	3.3 0.32	3.9 0.39	4.9 0.48	5.9 0.58	6.6 0.64	8.2 0.80	9.9 0.97	11.8 1.16

Motor Model	Gearbox Model	Gear Ratio r/min	36	40	50	60	75	90	100	120	150	180	200	250	300	360
			8DCG*-25-30	8GBK □ BMH	kgfcm N.m	21.3 2.09	23.7 2.32	26.8 2.62	32.1 3.15	40.1 3.93	48.2 4.72	53.5 5.25	64.2 6.29	80.0 7.84	80.0 7.84	80.0 7.84

Motor Model	Gearbox Model	GearRatio r/min	10	12	15	18	25	30	36	50	60
			8DCW*-25-30	8WD □ BL/ □ BR/ □ BRL	kgfcm N.m	6.7 0.65	7.8 0.76	9.4 0.92	10.8 1.06	14.2 1.39	16.1 1.57

- 1) Enter the voltage code in the place * within the motor model name. 2) Enter the gear ratio in the box (□) within the gearbox model name.
3) A colored background indicates the gear shaft rotation in the same direction as the motor shaft: a white background indicates the rotation in the opposite direction.
4) The rotating speed is calculated by dividing the motor's synchronous speed (50Hz: 1,500r/min, 60Hz: 1,800r/min) by the gear ratio. The actual speed is 2~20% less than the displayed value, depending on the size of the load.

Dimensions

MOTOR ONLY

- MOTOR MODEL: 8DCD□-25-30

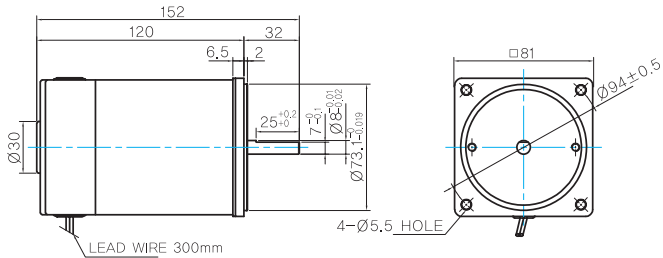

MOTOR OUTPUT SHAFT

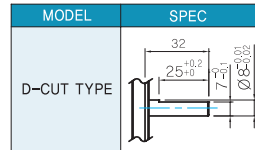

INTER-DECIMAL GEARBOX

- MODEL: 8XD10□□

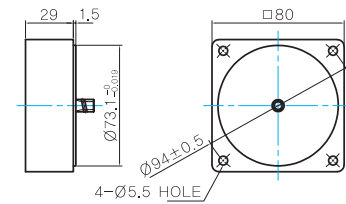

GEARED MOTOR

G TYPE GEARBOX

- MOTOR MODEL: 8DCG□-25-30

- GEARBOX MODEL: 8GBK□BMH

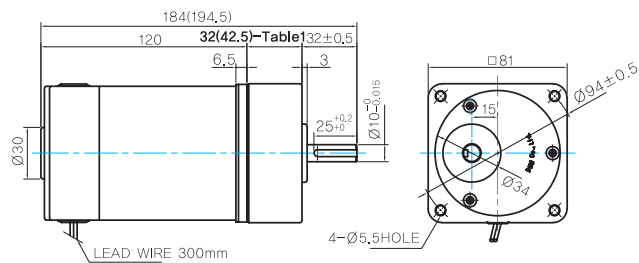

GEARBOX OUTPUT SHAFT

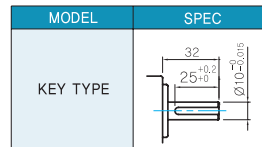

32(42.5)-Table1

SIZE(mm)	GEAR RATIO
32	8GBK3BMH ~ 8GBK18BMH
42.5	8GBK20BMH ~ 8GBK360BMH

KEY SPEC

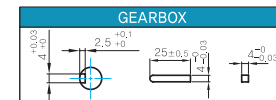

W TYPE GEARBOX

- MOTOR MODEL: 8DCW□-25-30

- GEARBOX MODEL: 8WD□BL/BR/BRL

KEY SPEC

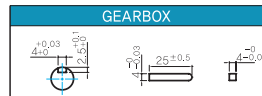

WEIGHT

PART	WEIGHT(Kg)	
MOTOR	1.65	
GEAR BOX	8GBK3BMH ~ 8GBK18BMH	0.56
	8GBK20BMH ~ 8GBK40BMH	0.65
	8GBK50BMH ~ 8GBK360BMH	0.72
	8WD□BL/BR/BRL	0.68
	8XD10□□	0.45

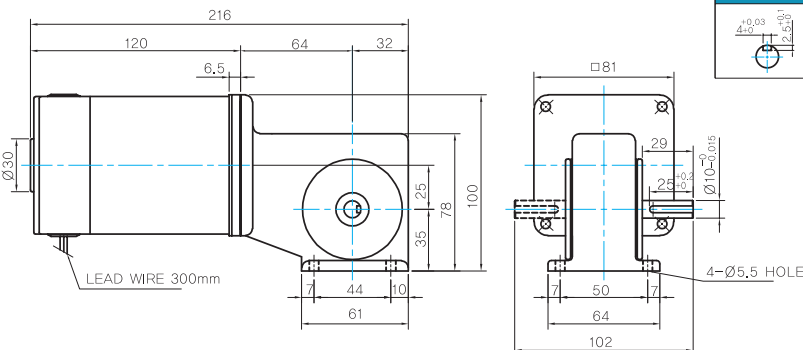

Motor Images



C DC Motors

DC Motor 40W(□ 80mm)

40W DC Motor 40W(□ 80mm)

Motor Specification

Model 8DCG(W)*-40-30: Gear Type Shaft 8DCD*-40-30: D-Cut Type Shaft	Output W	Voltage V	No Load		Starting Torque		Starting Current A	Rated Load			
			Speed r/min	Current A	kgfcm	N.m		Speed r/min	Current A	Torque kgfcm N.m	
8DC□12-40-30	40	12	3300	1.40	15.50	1.550	46.00	3000	4.80	1.30	0.130
8DC□24-40-30	40	24	3150	0.60	25.00	2.500	43.00	3000	2.50	1.30	0.130
8DC□90-40-30	40	90	3100	0.03	25.00	2.500	19.00	3000	0.55	1.30	0.130

1) Enter the voltage code in the place * and enter the output shaft type in the box (□) within the motor model name.

2) Gear Type Shaft is for attaching a gearbox and D-Cut Type Shaft is for using the motor only.

Performance Curve

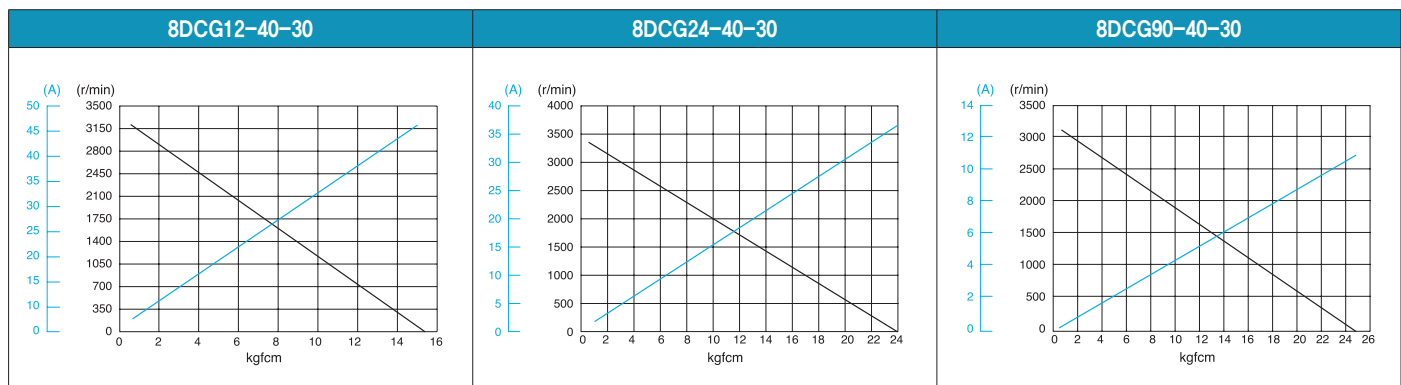

Max. Permissible Torque at Output Shaft of Gearbox

Motor Model	Gearbox Model	GearRatio r/min	3	3.6	5	6	7.5	9	10	12.5	15	18	20	25	30
			8DCG*-40-30	8GBK□BMH	kgfcm N.m	3.2 0.31	3.8 0.37	5.3 0.52	6.3 0.62	7.9 0.77	9.5 0.93	10.5 1.03	13.2 1.29	15.8 1.55	19.0 1.86

Motor Model	Gearbox Model	GearRatio r/min	36	40	50	60	75	90	100	120	150	180	200	250	300	360
			8DCG*-40-30	8GBK□BMH	kgfcm N.m	34.2 3.35	38.0 3.72	42.9 4.20	51.5 5.05	64.4 6.31	77.2 7.57	80.0 7.84	80.0 7.84	80.0 7.84	80.0 7.84	80.0 7.84

Motor Model	Gearbox Model	GearRatio r/min	10	12	15	18	25	30	36	50	60
			8DCW*-40-30	8WD□BL/□BR/□BRL	kgfcm N.m	10.7 1.04	12.5 1.22	15.0 1.47	17.3 1.70	22.8 2.23	25.7 2.52

1) Enter the voltage code in the place * within the motor model name. 2) Enter the gear ratio in the box (□) within the gearbox model name.

3) A colored background indicates the gear shaft rotation in the same direction as the motor shaft; a white background indicates the rotation in the opposite direction.

4) The rotating speed is calculated by dividing the motor's synchronous speed (50Hz: 1,500r/min, 60Hz: 1,800r/min) by the gear ratio. The actual speed is 2~20% less than the displayed value, depending on the size of the load.

Dimensions

MOTOR ONLY

- MOTOR MODEL: 8DCD□-40-30

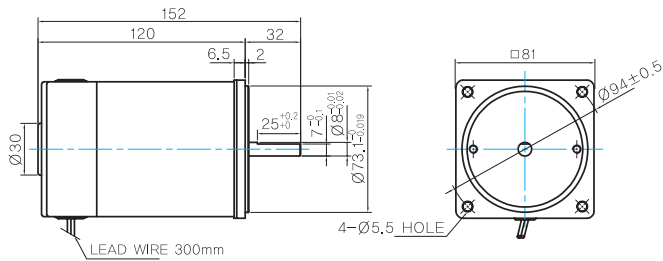

MOTOR OUTPUT SHAFT

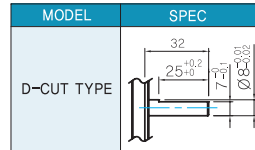

INTER-DECIMAL GEARBOX

- MODEL: 8XD10□□

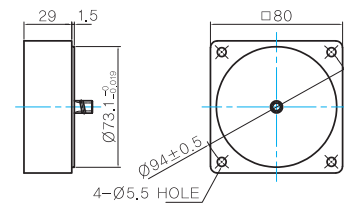

GEARED MOTOR

G TYPE GEARBOX

- MOTOR MODEL: 8DCG□-40-30

- GEARBOX MODEL: 8GBK□BMH

GEARBOX OUTPUT SHAFT

- 32(42.5)-Table1

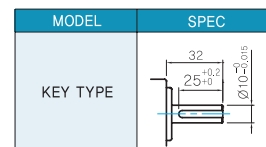
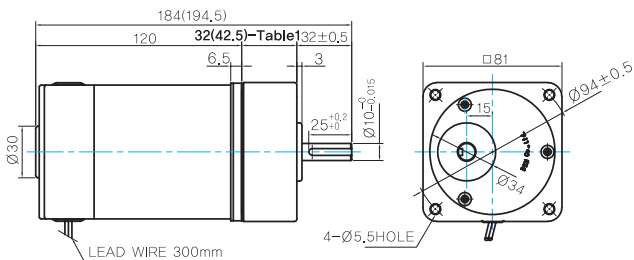

SIZE(mm)	GEAR RATIO
32	8GBK3BMH ~ 8GBK18BMH
42,5	8GBK20BMH ~ 8GBK360BMH

KEY SPEC

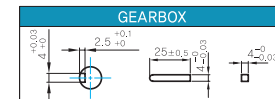

W TYPE GEARBOX

- MOTOR MODEL: 8DCW□-40-30

- GEARBOX MODEL: 8WD□BL/BR/BRL

KEY SPEC

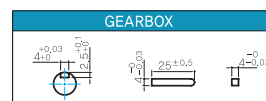
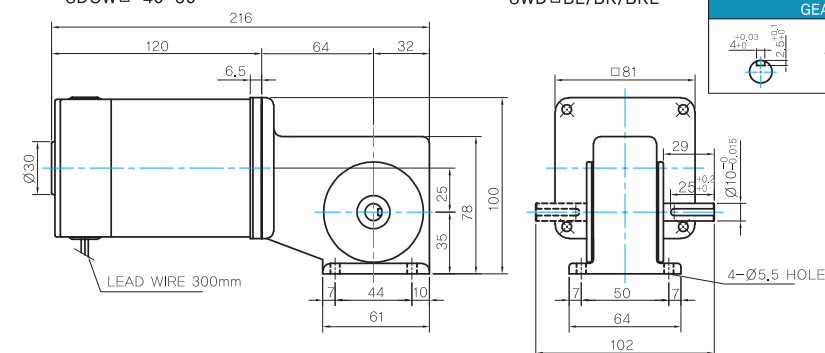

WEIGHT

PART	WEIGHT(Kg)	
MOTOR	1,7	
GEAR BOX	8GBK3BMH ~ 8GBK18BMH	0,56
	8GBK20BMH ~ 8GBK40BMH	0,65
	8GBK50BMH ~ 8GBK360BMH	0,72
	8WD□BL/BR/BRL	0,68
	8XD10□□	0,45

Motor Images



C DC Motors

DC Motor 60W(□ 90mm)

60W DC Motor 60W(□ 90mm)

Motor Specification

Model 9DCP(W)*-60-30: Gear Type Shaft 9DCD*-60-30: D-Cut Type Shaft 9DCK*-60-30: Key Type Shaft	Output W	Voltage V	No Load		Starting Torque		Starting Current A	Rated Load			
			Speed r/min	Current A	kgfcm	N.m		Speed r/min	Current A	Torque kgfcm N.m	
9DC □ 12-60-30	60	12	3250	2.50	21.00	2.100	65.00	3000	7.50	1.95	0.195
9DC □ 24-60-30	60	24	3150	1.00	19.00	1.900	29.00	2800	3.50	1.95	0.195
9DC □ 90-60-30	60	90	3100	0.25	27.30	2.730	11.00	2800	0.80	1.95	0.195

- 1) Enter the voltage code in the place * and enter the output shaft type in the box (□) within the motor model name.
2) Gear Type Shaft is for attaching a gearbox and D-Cut Type Shaft is for using the motor only.

Performance Curve

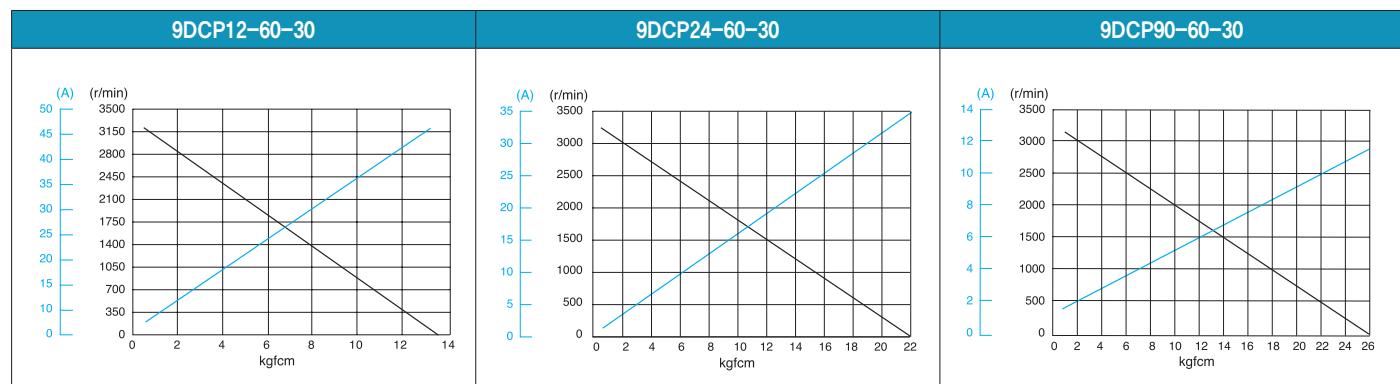

Max. Permissible Torque at Output Shaft of Gearbox

Motor Model	Gearbox Model	GearRatio r/min	2	3	3.6	5	6	7.5	9	10	12.5	15	18	20
			9DCP*-60-30	9PBK □ BH 9PFK □ BH	kgfcm N.m	3.2 0.31	4.7 0.46	5.7 0.56	7.9 0.77	9.5 0.93	11.8 1.16	14.2 1.39	15.8 1.55	17.8 1.74

Motor Model	Gearbox Model	GearRatio r/min	25	30	36	40	50	60	75	90	100	120	150	180	200
			9DCP*-60-30	9PBK □ BH 9PFK □ BH	kgfcm N.m	32.2 3.15	38.6 3.78	46.3 4.54	51.5 5.05	64.4 6.31	77.2 7.57	86.3 8.46	103.5 10.15	115.1 11.27	138.1 13.53

Motor Model	Gearbox Model	GearRatio r/min	10	12	15	18	25	30	36	50	60
			9DCW*-60-30	9WD □ BL/ □ BR/ □ BRL	kgfcm N.m	16.0 1.57	18.7 1.83	22.5 2.21	26.0 2.55	34.1 3.34	38.6 3.78

- 1) Enter the voltage code in the place * within the motor model name. 2) Enter the gear ratio in the box (□) within the gearbox model name.
3) A colored background indicates the gear shaft rotation in the same direction as the motor shaft; a white background indicates the rotation in the opposite direction.
4) The rotating speed is calculated by dividing the motor's synchronous speed (50Hz: 1,500r/min, 60Hz: 1,800r/min) by the gear ratio. The actual speed is 2~20% less than the displayed value, depending on the size of the load.

Dimensions

MOTOR ONLY

- MOTOR MODEL: 9DCD□-60-30

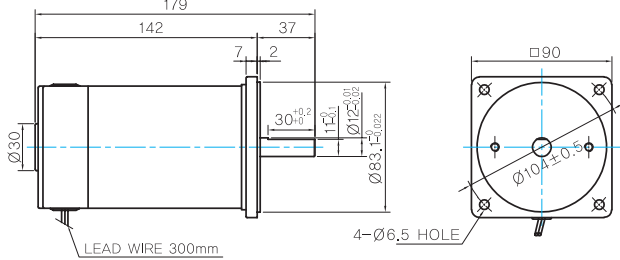

MOTOR OUTPUT SHAFT

MODEL	SPEC
D-CUT TYPE	37 30 ^{+0.02} ₋₀ 1.1 ^{+0.01} ₋₀ Ø12 ^{+0.01} ₋₀
KEY TYPE	37 25 ^{+0.01} ₋₀ Ø12 ^{+0.01} ₋₀

KEY SPEC

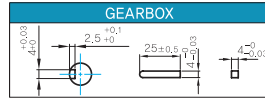

INTER-DECIMAL GEARBOX

- MODEL: 9XD10□□

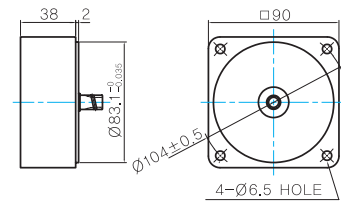

GEARED MOTOR

P TYPE GEARBOX

- MOTOR MODEL: 9DCP□-60-30

- GEARBOX MODEL: 9PBK□BH

- GEARBOX MODEL: 9PFK□BH

GEARBOX OUTPUT SHAFT

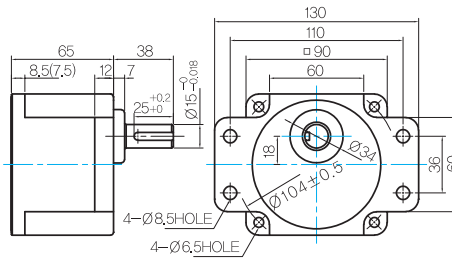
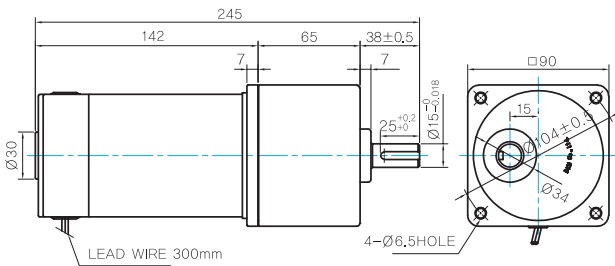

MODEL	SPEC
KEY TYPE	38 25 ^{+0.02} ₋₀ Ø15 ^{+0.01} ₋₀

KEY SPEC

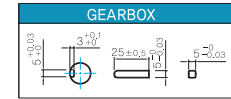

W TYPE GEARBOX

- MOTOR MODEL: 9DCW□-60-30

- GEARBOX MODEL: 9WD□BL/BR/BRL

KEY SPEC

WEIGHT

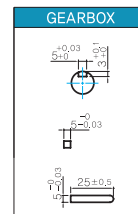
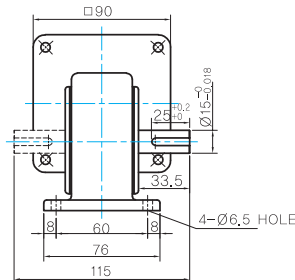
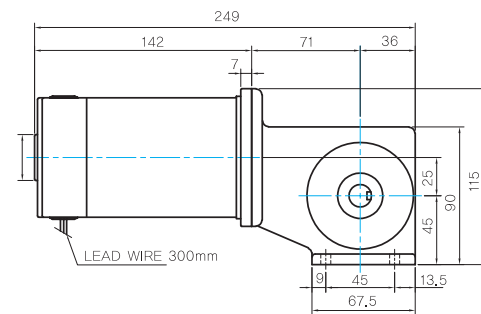

PART	WEIGHT(Kg)	
MOTOR	2.0	
GEAR BOX	9PB(F)K2BH ~ 9PB(F)K10BH	1.28
	9PB(F)K12.5BH ~ 9PB(F)K20BH	1.3
	9PB(F)K25BH ~ 9PB(F)K60BH	1.45
	9PB(F)K75BH ~ 9PB(F)K200BH	1.47
9WD□BL/BR/BRL	1.0	
9XD10□□	0.6	

Motor Images

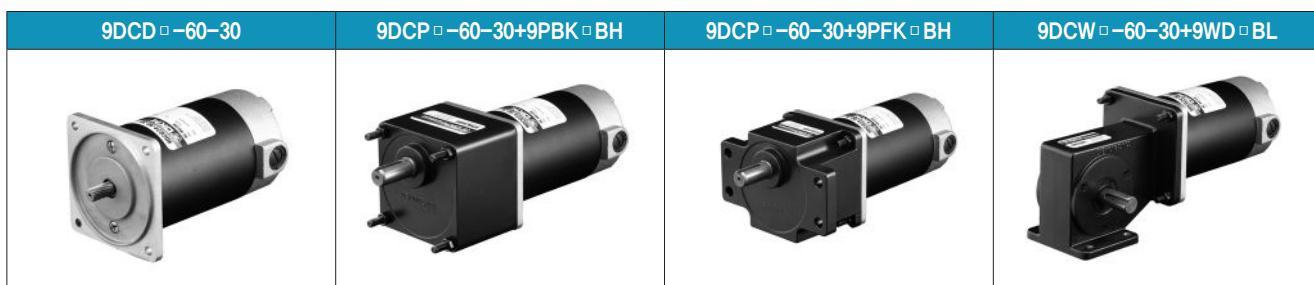

C DC Motors

DC Motor 90W(□ 90mm)

90W DC Motor 90W(□ 90mm)

Motor Specification

Model 9DCP(W)*-90-30: Gear Type Shaft 9DCD*-90-30: D-Cut Type Shaft 9DCK*-90-30: Key Type Shaft	Output W	Voltage V	No Load		Starting Torque		Starting Current A	Rated Load			
			Speed r/min	Current A	kgfcm	N.m		Speed r/min	Current A	Torque kgfcm N.m	
9DC □ 12-90-30	90	12	3400	3.50	21.00	2.100	67.00	3000	11.00	2.92	0.292
9DC □ 24-90-30	90	24	3050	1.10	25.50	2.550	33.00	2700	5.00	2.92	0.292
9DC □ 90-90-30	90	90	3200	0.30	31.90	3.190	14.50	3000	1.50	2.92	0.292

- 1) Enter the voltage code in the place * and enter the output shaft type in the box (□) within the motor model name.
2) Gear Type Shaft is for attaching a gearbox and D-Cut Type Shaft is for using the motor only.

Performance Curve

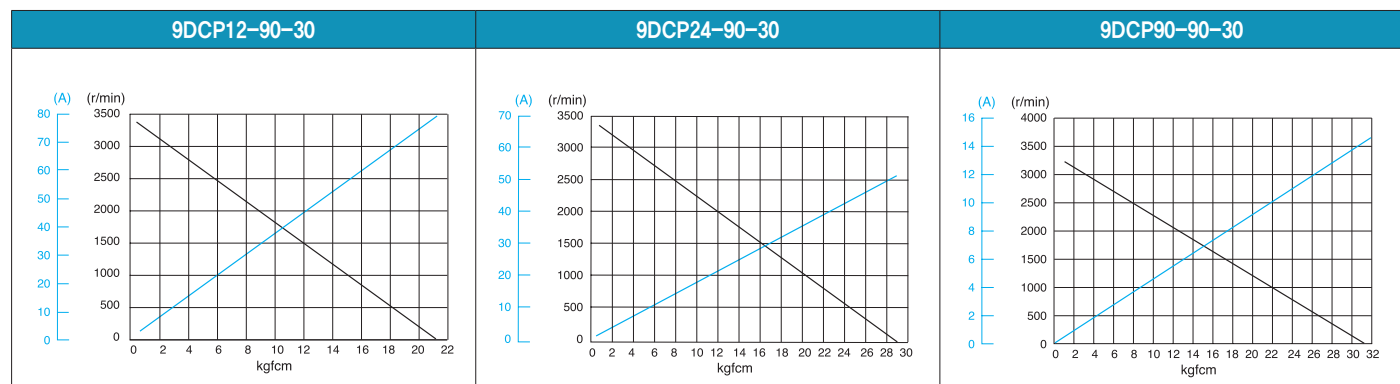

Max. Permissible Torque at Output Shaft of Gearbox

Motor Model	Gearbox Model	GearRatio	2	3	3.6	5	6	7.5	9	10	12.5	15	18	20
			r/min	1500	1000	833	600	500	400	333	300	240	200	167
9DCP*-90-30	9PBK □ BH 9PFK □ BH	kgfcm	4.7	7.1	8.5	11.8	14.2	17.7	21.3	23.7	26.6	32.0	38.4	42.6
		N.m	0.46	0.70	0.83	1.16	1.39	1.74	2.09	2.32	2.61	3.13	3.76	4.18

Motor Model	Gearbox Model	GearRatio	25	30	36	40	50	60	75	90	100	120	150	180	200
			r/min	120	100	83	75	60	50	40	33	30	25	20	17
9DCP*-90-30	9PBK □ BH 9PFK □ BH	kgfcm	48.2	57.8	69.4	77.1	96.4	115.6	129.2	155.1	172.3	200.0	200.0	200.0	200.0
		N.m	4.72	5.67	6.80	7.55	9.44	11.33	12.66	15.20	16.88	19.60	19.60	19.60	19.60

Motor Model	Gearbox Model	GearRatio	10	12	15	18	25	30	36	50	60
			r/min	300	250	200	167	120	100	83	60
9DCW*-90-30	9WD □ BL/ □ BR/ □ BRL	kgfcm	23.9	28.0	33.7	38.9	51.1	57.8	67.3	87.6	96.4
		N.m	2.35	2.75	3.31	3.81	5.01	5.67	6.59	8.58	9.44

- 1) Enter the voltage code in the place * within the motor model name. 2) Enter the gear ratio in the box (□) within the gearbox model name.
3) A colored background indicates the gear shaft rotation in the same direction as the motor shaft; a white background indicates the rotation in the opposite direction.
4) The rotating speed is calculated by dividing the motor's synchronous speed (50Hz: 1,500r/min, 60Hz: 1,800r/min) by the gear ratio. The actual speed is 2~20% less than the displayed value, depending on the size of the load.

Dimensions

MOTOR ONLY

- MOTOR MODEL: 9DCD□-90-30

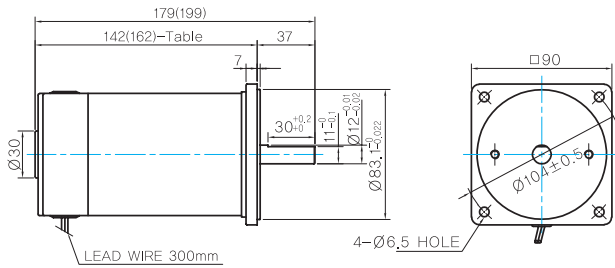

MOTOR OUTPUT SHAFT

MODEL	SPEC
D-CUT TYPE	
9DCD□-90-30	
KEY TYPE	
9DCK□-90-30	

KEY SPEC

GEARBOX

INTER-DECIMAL GEARBOX

- MODEL: 9XD10□□

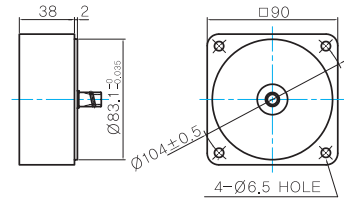

142(162)-Tablet

SIZE(mm)	MOTOR VOLTAGE
142	24V,90V
162	12V

GEARED MOTOR

P TYPE GEARBOX

- MOTOR MODEL: 9DCP□-90-30

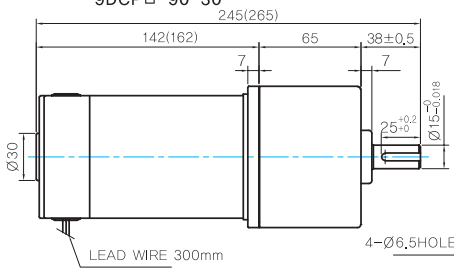

- GEARBOX MODEL: 9PBK□BH

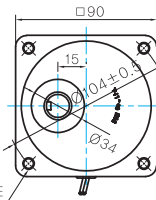

- GEARBOX MODEL: 9PFK□BH

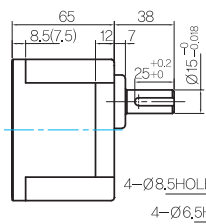

GEARBOX OUTPUT SHAFT

MODEL	SPEC
KEY TYPE	
9PBK□BH	
9PFK□BH	

KEY SPEC

GEARBOX

W TYPE GEARBOX

- MOTOR MODEL: 9DCW□-90-30

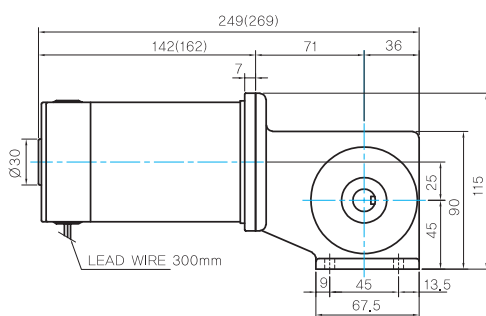

- GEARBOX MODEL: 9WD□BL/BR/BRL

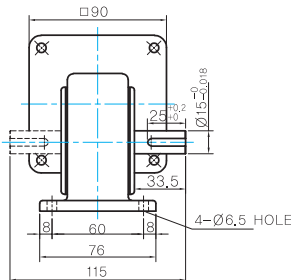

KEY SPEC

GEARBOX

WEIGHT

PART	WEIGHT(Kg)	
MOTOR	2,1	
GEAR BOX	9PB(F)K2BH ~ 9PB(F)K10BH	1,28
	9PB(F)K12.5BH ~ 9PB(F)K20BH	1,3
	9PB(F)K25BH ~ 9PB(F)K60BH	1,45
	9PB(F)K75BH ~ 9PB(F)K200BH	1,47
	9WD□BL/BR/BRL	1,0
9XD10□□	0,6	

Motor Images

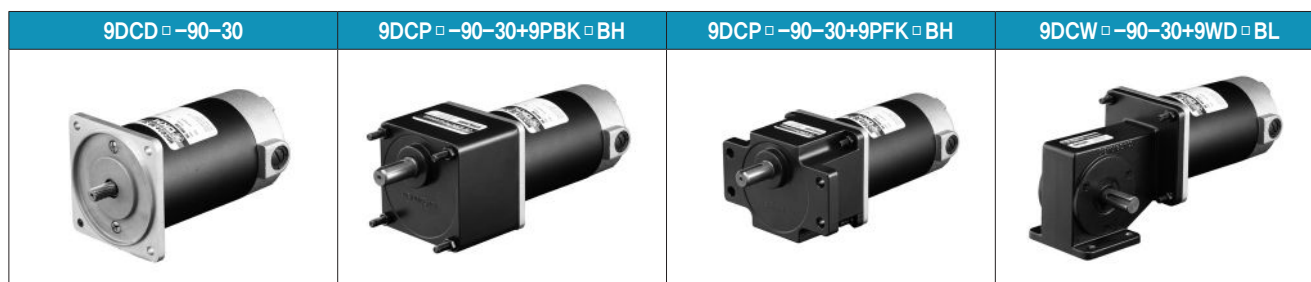

C DC Motors

DC Motor 120W(□ 90mm)

120W DC Motor 120W(□ 90mm)

Motor Specification

Model 9DCP(W)*-120-30: Gear Type Shaft 9DCD*-120-30: D-Cut Type Shaft 9DCK*-120-30: Key Type Shaft	Output W	Voltage V	No Load		Starting Torque		Starting Current A	Rated Load			
			Speed r/min	Current A	kgfcm	N.m		Speed r/min	Current A	Torque kgfcm N.m	
9DC□12-120-30	120	12	3400	3.50	25.00	2.500	75.00	3000	15.00	3.90	0.390
9DC□24-120-30	120	24	3050	1.30	34.00	3.400	62.00	2800	7.20	3.90	0.390
9DC□90-120-30	120	90	3400	0.50	34.00	3.400	18.00	3000	2.00	3.90	0.390

- 1) Enter the voltage code in the place * and enter the output shaft type in the box (□) within the motor model name.
2) Gear Type Shaft is for attaching a gearbox and D-Cut Type Shaft is for using the motor only.

Performance Curve

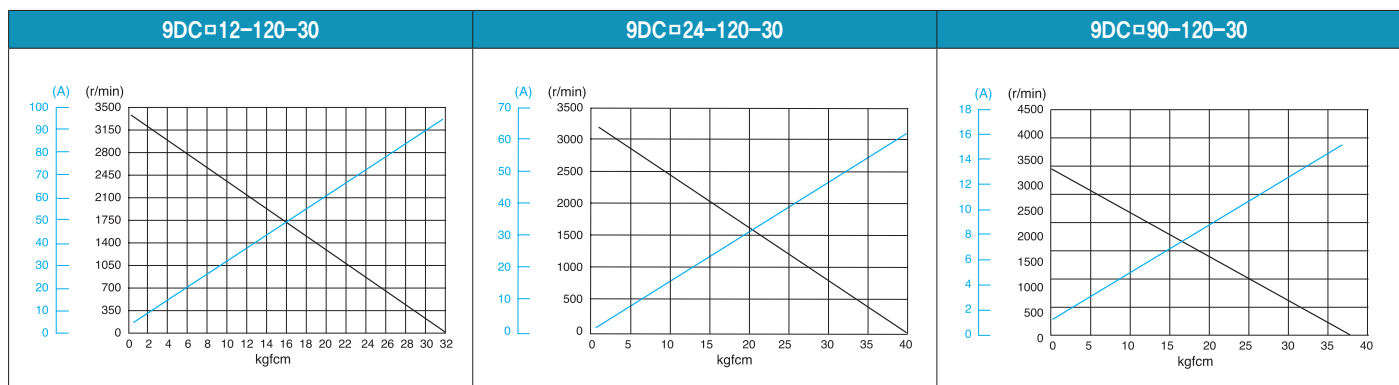

Max. Permissible Torque at Output Shaft of Gearbox

Motor Model	Gearbox Model	GearRatio	2	3	3.6	5	6	7.5	9	10	12.5	15	18	20
			r/min	1500	1000	833	600	500	400	333	300	240	200	167
9DCP*-120-30	9PBK□BH 9PFK□BH	kgfcm	6.3	9.5	11.4	15.8	19.0	23.7	28.4	31.6	35.6	42.7	51.2	56.9
		N.m	0.62	0.93	1.11	1.55	1.86	2.32	2.79	3.10	3.49	4.19	5.02	5.58

Motor Model	Gearbox Model	GearRatio	25	30	36	40	50	60	75	90	100	120	150	180	200
			r/min	120	100	83	75	60	50	40	33	30	25	20	17
9DCP*-120-30	9PBK□BH 9PFK□BH	kgfcm	64.4	77.2	92.7	103.0	128.7	154.4	172.6	200.0	200.0	200.0	200.0	200.0	200.0
		N.m	6.31	7.57	9.08	10.09	12.61	15.14	16.91	19.60	19.60	19.60	19.60	19.60	19.60

Motor Model	Gearbox Model	GearRatio	10	12	15	18	25	30	36	50	60
			r/min	300	250	200	167	120	100	83	60
9DCW*-120-30	9WD□BL/□BR/□BRL	kgfcm	32.0	37.4	45.0	51.9	68.3	77.2	89.9	117.0	122.4
		N.m	3.13	3.67	4.41	5.09	6.69	7.57	8.81	11.47	12.00

- 1) Enter the voltage code in the place * within the motor model name. 2) Enter the gear ratio in the box (□) within the gearbox model name.
3) A colored background indicates the gear shaft rotation in the same direction as the motor shaft; a white background indicates the rotation in the opposite direction.
4) The rotating speed is calculated by dividing the motor's synchronous speed (50Hz: 1,500r/min, 60Hz: 1,800r/min) by the gear ratio. The actual speed is 2~20% less than the displayed value, depending on the size of the load.

Dimensions

MOTOR ONLY

- MOTOR MODEL: 9DCD□-120-30

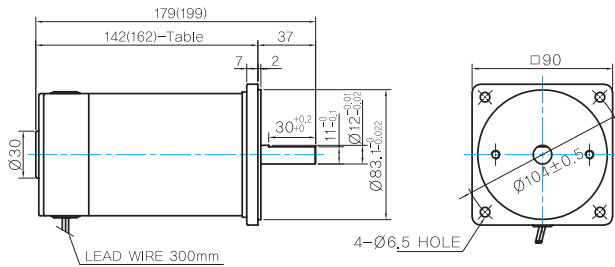

MOTOR OUTPUT SHAFT

MODEL	SPEC
D-CUT TYPE	
9DCD□-120-30	
KEY TYPE	
9DCK□-120-30	

KEY SPEC

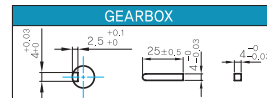

INTER-DECIMAL GEARBOX

- MODEL: 9XD10□□

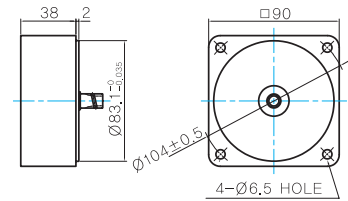

142(162)-Table1

SIZE(mm)	MOTOR VOLTAGE
142	24V,90V
162	12V

GEARED MOTOR

P TYPE GEARBOX

- MOTOR MODEL: 9DCP□-120-30

- GEARBOX MODEL: 9PBK□BH

- GEARBOX MODEL: 9PFK□BH

GEARBOX OUTPUT SHAFT

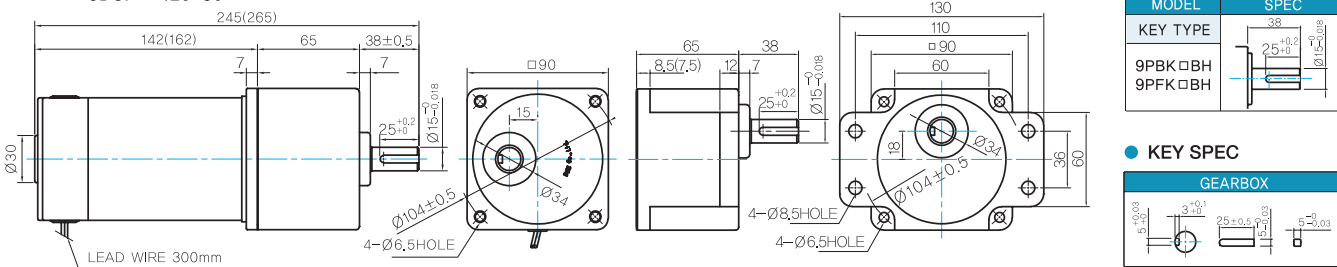

MODEL	SPEC
KEY TYPE	
9PBK□BH	
9PFK□BH	

KEY SPEC

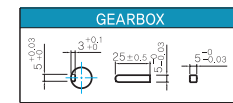

W TYPE GEARBOX

- MOTOR MODEL: 9DCW□-120-30

- GEARBOX MODEL: 9WD□BL/BR/BRL

KEY SPEC

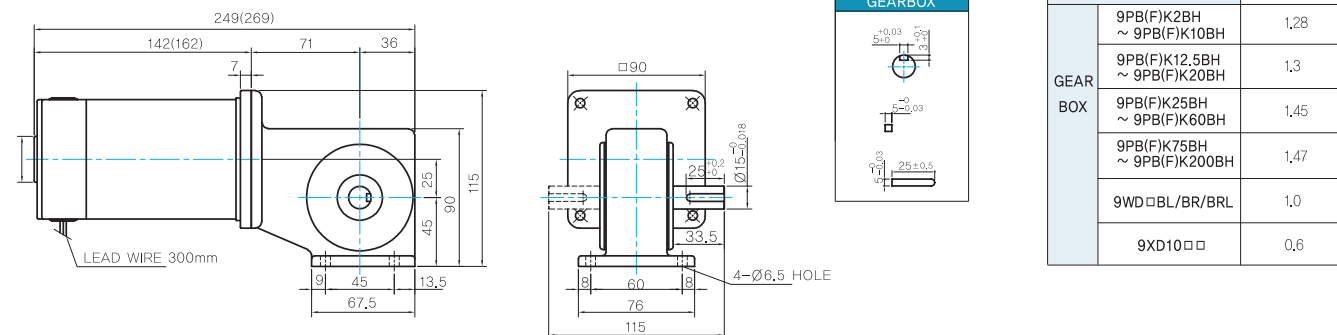

GEARBOX

WEIGHT

PART	WEIGHT(Kg)	
MOTOR	2,1	
GEAR BOX	9PB(F)K2BH ~ 9PB(F)K10BH	1,28
	9PB(F)K12.5BH ~ 9PB(F)K20BH	1,3
	9PB(F)K25BH ~ 9PB(F)K60BH	1,45
	9PB(F)K75BH ~ 9PB(F)K200BH	1,47
	9WD□BL/BR/BRL	1,0
9XD10□□	0,6	

Motor Images

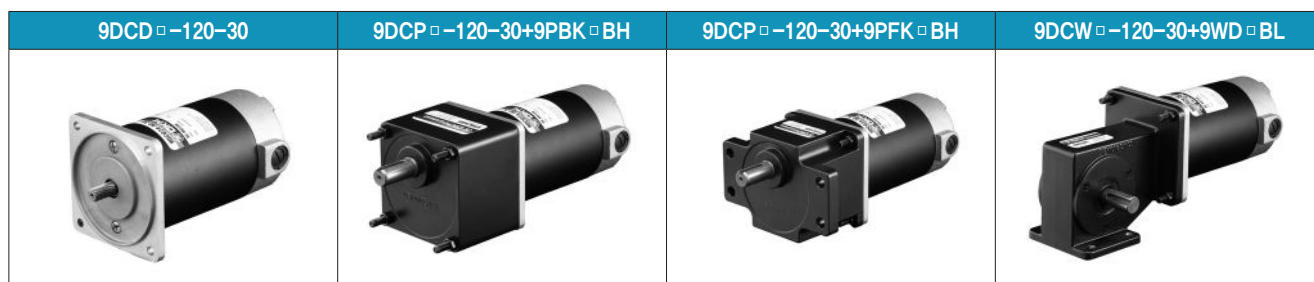

C DC Motors

DC Motor 200W(□ 90mm)

200W DC Motor 200W(□ 90mm)

Motor Specification

Model 9DCH*-200-30: Gear Type Shaft 9DCD*-200-30: D-Cut Type Shaft 9DCK*-200-30: Key Type Shaft	Output W	Voltage V	No Load		Starting Torque		Starting Current A	Rated Load			
			Speed r/min	Current A	kgfcm	N.m		Speed r/min	Current A	Torque kgfcm N.m	
9DC □ 12-200-30	200	12	3300	5.00	30.00	3.000	98.00	2800	28.00	6.95	0.695
9DC □ 24-200-30	200	24	3400	2.00	57.50	5.750	105.00	3000	13.00	6.50	0.650
9DC □ 90-200-30	200	90	3400	0.50	48.00	4.800	28.00	3000	3.50	6.50	0.650

- 1) Enter the voltage code in the place * and enter the output shaft type in the box (□) within the motor model name.
2) Gear Type Shaft is for attaching a gearbox and D-Cut Type Shaft is for using the motor only.

Performance Curve

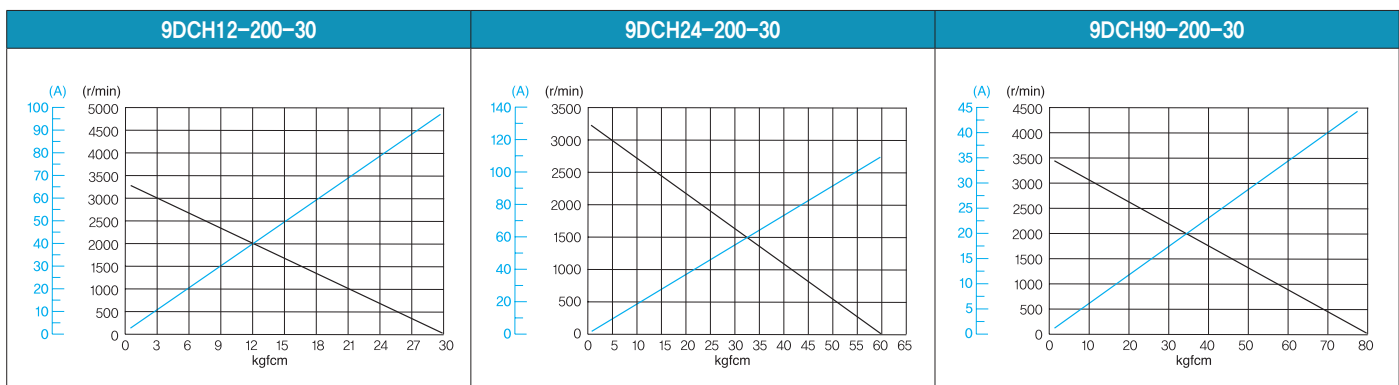

Max. Permissible Torque at Output Shaft of Gearbox

Motor Model	Gearbox Model	GearRatio	3	3.6	5	6	7.5	9	10	12.5	15	18	20	25
			r/min	1000	833	600	500	400	333	300	240	200	167	150
9DCH*-200-30	9HBK □ BH 9HFK □ BH	kgfcm	15.8	19.0	26.3	31.6	39.5	47.4	52.7	59.3	71.2	85.4	94.9	107.3
		N.m	1.55	1.86	2.58	3.10	3.87	4.64	5.16	5.81	6.98	8.37	9.30	10.51
Motor Model	Gearbox Model	GearRatio	30	36	40	50	60	75	90	100	120	150	180	200
			r/min	100	83	75	60	50	40	33	30	25	20	17
9DCH*-200-30	9HBK □ BH 9HFK □ BH	kgfcm	128.7	154.4	171.6	214.5	257.4	300.0	300.0	300.0	300.0	300.0	300.0	300.0
		N.m	12.61	15.14	16.82	21.02	25.23	29.40	29.40	29.40	29.40	29.40	29.40	29.40

- 1) Enter the voltage code in the place * within the motor model name. 2) Enter the gear ratio in the box (□) within the gearbox model name.
3) A colored background indicates the gear shaft rotation in the same direction as the motor shaft; a white background indicates the rotation in the opposite direction.
4) The rotating speed is calculated by dividing the motor's synchronous speed (50Hz: 1,500r/min, 60Hz: 1,800r/min) by the gear ratio. The actual speed is 2~20% less than the displayed value, depending on the size of the load.

Dimensions (12 / 24V)

MOTOR ONLY

- MOTOR MODEL: 9DCD□-200-30
205,5(220,5)

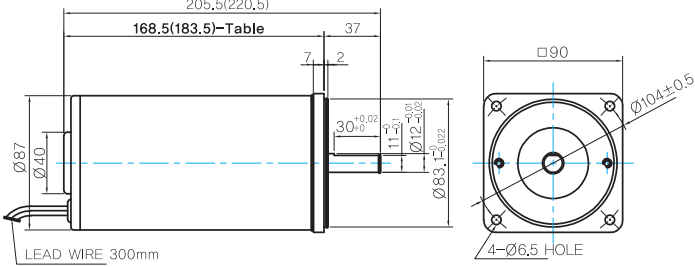

MOTOR OUTPUT SHAFT

MODEL	SPEC
D-CUT TYPE	
9DCD□-200-30	
KEY TYPE	
9DCK□-200-30	

KEY SPEC

GEARBOX

168.5(183.5)-Table1

SIZE(mm)	MOTOR VOLTAGE
168.5	24V
183.5	12V

GEARED MOTOR

H TYPE GEARBOX

- MOTOR MODEL: 9DCH□-200-30

- GEARBOX MODEL: 9HBK□BH

- GEARBOX MODEL: 9HFK□BH

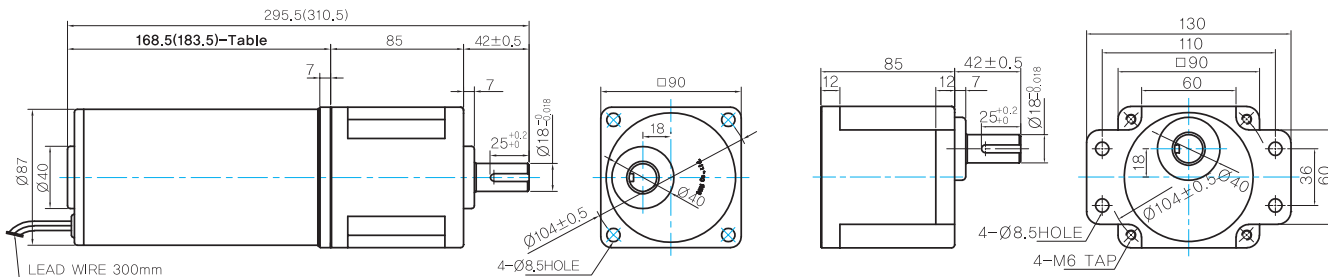

GEARBOX OUTPUT SHAFT

MODEL	SPEC
KEY TYPE	

KEY SPEC

GEARBOX

WEIGHT

	PART	WEIGHT(Kg)
MOTOR	9DCD12-200-30	3,8
	9DCD24-200-30	3,55
GEAR BOX	9HB(F)K3BH ~ 9HB(F)K10BH	1,62
	9HB(F)K12.5BH ~ 9HB(F)K20BH	1,68
	9HB(F)K25BH ~ 9HB(F)K60BH	1,73
	9HB(F)K75BH ~ 9HB(F)K200BH	1,78
	9XD10□□	0,6

* The output flange and shaft are sold separately.

Motor Images



C DC Motors

DC Motor 200W(□90mm)

Dimensions (90V)

MOTOR ONLY

- MOTOR MODEL: 9DCD90-200-30

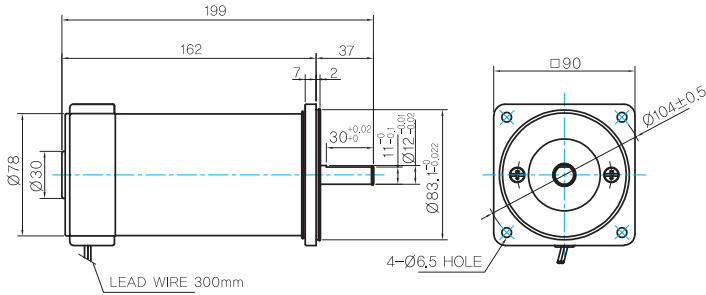

MOTOR OUTPUT SHAFT

MODEL	SPEC
D-CUT TYPE	
KEY TYPE	

KEY SPEC

GEARBOX

GEARED MOTOR

H TYPE GEARBOX

- MOTOR MODEL: 9DCH90-200-30

- GEARBOX MODEL: 9HBK□BH

- GEARBOX MODEL: 9HFK□BH

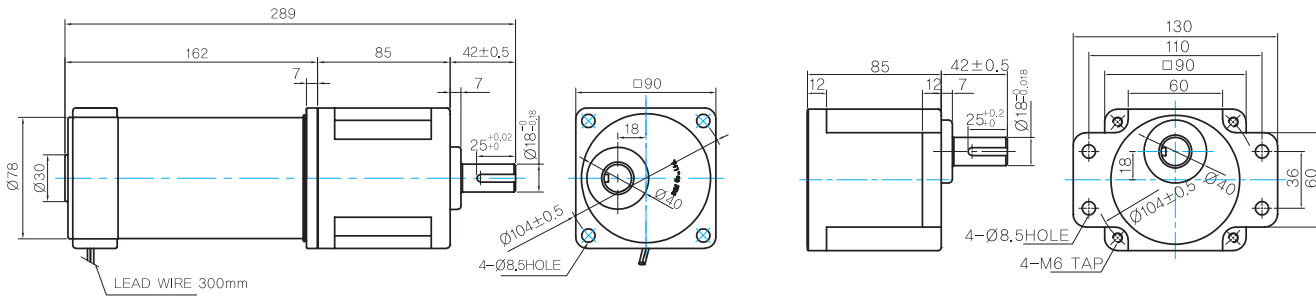

GEARBOX OUTPUT SHAFT

MODEL	SPEC
KEY TYPE	

KEY SPEC

GEARBOX

WEIGHT

MOTOR	PART	WEIGHT(kg)
	9DCD90-200-30	2,85
GEAR BOX	9HB(F)K3BH ~ 9HB(F)K10BH	1,62
	9HB(F)K12.5BH ~ 9HB(F)K20BH	1,68
	9HB(F)K25BH ~ 9HB(F)K60BH	1,73
	9HB(F)K75BH ~ 9HB(F)K200BH	1,78
	9XD10□□	0,6

* The output flange and shaft are sold separately

Motor Images



DSD-90

Speed Controller

Features

- DSD-90 is for adjusting the speed of DC motor, (Applicable to DC 90V)
- Easy speed adjustment by potentiometer on front panel

General Specifications

Item	DSD-90
Rated Voltage	AC 220V 50/60Hz
Voltage Regulation	±10%
Allowable Current	Below 4A
Control System	Phase control
Speed control	Operate with dial
Motor Output	15W ~ 200W
Ambient Temperature	-10°C ~ 40°C
Ambient Humidity	35~85%RH
Insulation Resistance	Over 100MΩ(Base on 500VDC mega)
Dielectric Strength	1500VAC 50/60 for 1minute

Images



Dimensions

DSD-90

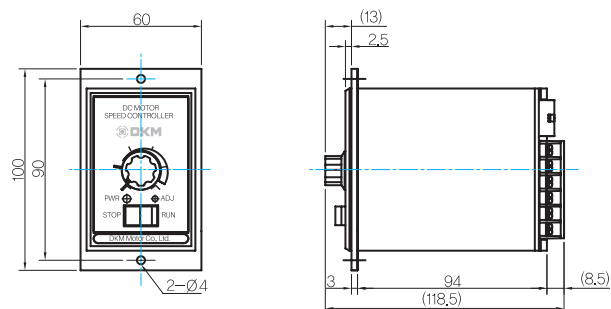

Connection Diagram

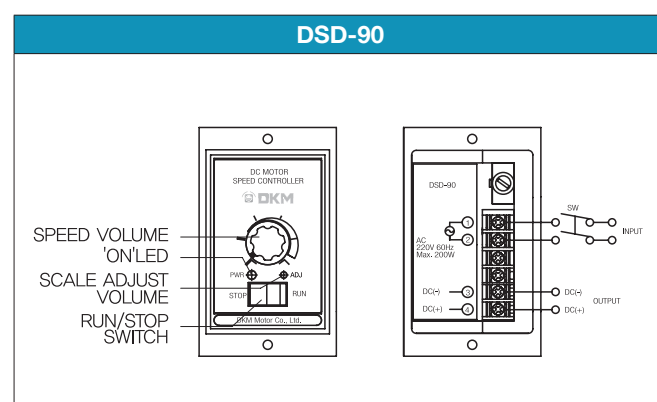

- 1) when the motor is operated, the temperature of the motor surface should be below 80°C.
- 2) It takes time to reverse the direction, Please reverse the direction after switch off the machine and the motor stops completely.
- 3) Depending on the torque load, Voltage Drop(VD) can occur.
- 4) ADJ is set based on 220V 60Hz, so please contact us if there is any change in the input voltage used. (Output DC 90V at input AC 220V 60Hz)

AC/DC Geared Motor and Gearbox

Gearboxes





A Information

- A-01 Product Coding System
- A-04 Product Lineup
- A-09 Combination table
- A-13 General Information
- A-17 Terminology
- A-20 Caution for Use

B AC Motors

- B-01 Technical Data of AC Motor
- B-06 Induction Motor
- B-58 2 Pole Motor
- B-76 Reversible Motor
- B-112 Brake Motor
- B-162 Clutch & Brake Motor
- B-178 Torque Motor
- B-206 Speed Control System
 - B-209 Speed Controller FX3000
 - B-213 Speed Controller DX3000
 - B-217 Speed Controller DSA
 - B-219 Speed Controller DSKM
 - B-224 Speed Control Induction Motor
 - B-258 Speed Control Reversible Motor
 - B-288 Speed Control Brake Motor
 - B-322 Speed Control Clutch & Brake Motor
- B-336 DSY Series

C DC Motors

- C-01 Technical Data of DC Motor
- C-04 DC Motor
- C-20 Speed Controller DSD-90

D Gearboxes

- D-01 Technical Data of Gearbox
- D-07 Parallel Gearbox
- D-13 Right-Angle Gearbox
- D-18 Inter-decimal Gearbox

E Options

- E-01 Mounting Bracket
- E-03 Extension Cable
- E-04 Output Flange / Output Shaft

D Gearbox

Technical Data of Gearbox

Definition and Function of Gearbox

It is a speed converter using gears and an instrumental device to reduce the rpm of the motor into the required rpm and get a bigger torque.

Types of DKM Gearboxes

According to Frame Size

Frame Size □60mm Gearbox / Frame Size □70mm Gearbox / Frame Size □80mm Gearbox / Frame Size □90mm Gearbox / Frame Size □104mm Gearbox

According to Direction of Output Shaft of Gearbox

Parallel Gearbox

Parallel Gearbox is the most common type in the small geared motor. DKM Motor employs spur type and helical type. Especially the helical gear is employed for low-noise and high-strength performance. Regarding noise, the important part of the gear is the contacting point with a motor shaft that rotates rapidly. DKM employed helical gear which cut high precisely at that point and realized low-noise performance.

General Box Type (GB Type)	Powerful Box Type (PB Type)	Powerful Flange Type (PF Type)	High Powerful Box Type (HB Type)	High Powerful Flange Type (HF Type)	Ultra Powerful Box Type (UB Type)	Inter-decimal Gearbox
Spur Gear			Helical Gear			
<p>The spur gear is cylindrical gear on which the teeth are cut parallel to the shaft.</p>			<p>The helical gear has teeth cut in helical curve. Its high rate of contact has the advantages of low noise and higher strength compared to the spur gear.</p>			

Right-Angle Gearbox

Right-Angle Gearbox has the advantage of using the limited space with high efficiency and realizes the cost saving effect by the reduction of using power transmission part like coupling. DKM has worm solid type, worm hollow type and helicross type.

Worm Solid Type (W Type, Left Output Shaft)	Worm Solid Type (W Type, Right Output Shaft)	Worm Solid Type (W Type, Bi-Directional Output Shaft)	Worm Hollow Type (WH Type)	Helicross Type (HC Type)
Worm wheel			Helicross gear	
<p>Worm Gear transmits power to right-angle direction by threaded worm and worm wheel.</p>				

☉ List of Gearbox Type

Type		Motor Output	Gearbox Model	Bearing Type	Frame Type
Parallel Gearbox	G Type (General)	6W	6GBD □ MH	Metal Bearing	Box Type
		6W, 10W, 15W	7GBK □ BMH	Ball Bearing + Metal Bearing	Box Type
		15W, 25W, 40W	8GBK □ BMH	Ball Bearing + Metal Bearing	Box Type
		40W	9GBK □ BMH	Ball Bearing + Metal Bearing	Box Type
	P Type (Powerful)	40~120W	9PBK □ BH	Ball Bearing	Box Type
			9PFK □ BH	Ball Bearing	Flange Type
	H Type (High Powerful)	60~200W	9HBK □ BH	Ball Bearing	Box Type
			9HFK □ BH	Ball Bearing	Flange Type
U Type (Ultra Powerful)	250W, 300W, 400W	10UBK □ BH	Ball Bearing	Box Type	
Right-Angle Gearbox	W Type (Worm Solid)	15~40W	8WD □ BL/BR/BRL	Ball Bearing	-
		40~120W	9WD □ BL/BR/BRL	Ball Bearing	-
	WH Type (Worm Hollow)	60~200W	9WHD □ -030	Ball Bearing	-
		150~200W	9WHD □ -040	Ball Bearing	-
		250W, 300W, 400W	10WHD □ -040	Ball Bearing	-
	HC Type	90~200W	9HC □ □	Ball Bearing	-
		250W, 300W, 400W	10HC □ □	Ball Bearing	-
Inter-decimal Gearbox		15~40W	8XD10 □ □	Metal Bearing	Box Type
		40~200W	9XD10 □ □	Ball Bearing	Box Type

☉ Maximum Permissible Torque and Efficiency of Gearbox

The output torque of gearbox is in proportion to the gear ratio. But there is limit in the size of load which can be applied to the gearbox in specific gear ratio depending on gear construction and materials etc. affecting the gearbox mechanical strength. This torque is called the maximum permissible torque. Two types of maximum permissible torque of general gearboxes are shown in the figure.

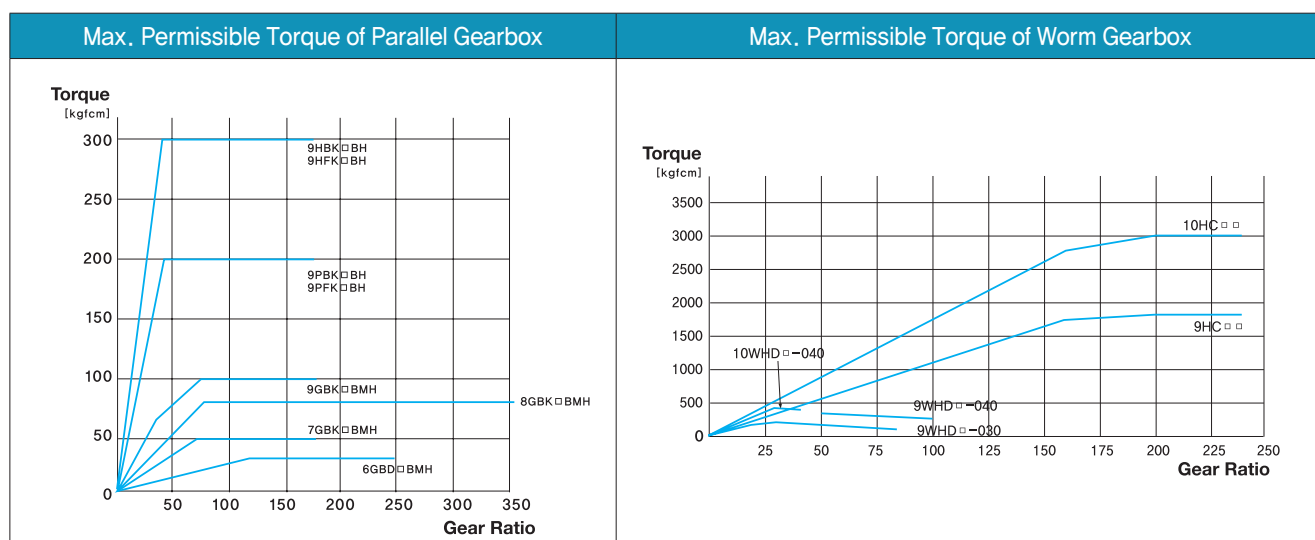

- The calculation of permissible torque at the output shaft of the gearbox is as below:

$$TG = TM \times i \times \eta$$

TG: Output torque of Gearbox TM: Motor torque i: Gear reduction ratio η: Gearbox efficiency

D Gearbox

Technical Data of Gearbox

● Efficiency of Parallel Gearbox

Model	Ratio	2	3	3.6	5	6	7.5	9	10	13	15	18	20	25	30	36	40	50	60	75	90	100	120	150	180	200	250	300	360		
6GBD □ MH		81%												73%						66%											
7GBK □ BMH		81%												73%						66%											
8GBK □ BMH		81%												73%						66%											
9GBK □ BMH		81%												73%						66%											
9PB(F)K □ BH		81%												73%						66%						59%					
9HB(F)K □ BH		81%												73%						66%						59%					
10UBK □ BH		81%												73%						66%						59%					

*The efficiency of inter-decimal gearbox (8XD10M □, 9XD10M □) is 81%.

● Efficiency of Right-Angle Gearbox

Model	Ratio	5	7.5	10	12	15	18	20	25	30	36	40	50	60	80	100	
9WHD □ -030		60%										55%					
9WHD □ -040		60%										55%					
10WHD □ -040		60%										55%					

Model	Ratio	15	20	25	30	40	50	60	80	100	120	160	200	225	240	
9HC □ □		66%	73%							66%						
10HC □ □		66%	73%							66%						

⊙ Speed and Direction of Rotations

⊙ Speed

This refers to the speed of rotation at the gearbox output shaft. The speed is calculated by dividing the motor's synchronous speed by the gear ratio. The actual speed, according to the load condition, is 2~20% less than the displayed value. The speed is calculated with the following equation:

$$NG = \frac{NM}{i} \text{ [r/min]}$$

NG: Speed of Gearbox [r/min]
 NM: Speed of Motor [r/min]
 i: Gear reduction ratio

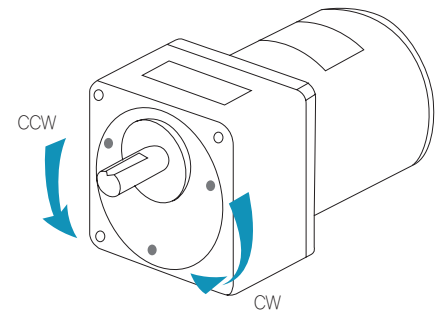

⊙ Direction of Rotation

This refers to the direction of rotation viewed from the output shaft. The direction of shaft rotation may differ from motor shaft rotation depending on the gear ratio of the gearbox.

● Rotating Direction of Gearbox Output Shaft

Model	Ratio	2	3	3.6	5	6	7.5	9	10	12.5	15	18	20	25	30	36	40	50	60	75	90	100	120	150	180	200	250	300	360
6GBD □ MH/BH		-	-	-	-	-	-	-	-	-	-	-	-	-	-	-	-	-	-	-	-	-	-	-	-	-	-	-	-
7GBK □ BMH/BH		-	-	-	-	-	-	-	-	-	-	-	-	-	-	-	-	-	-	-	-	-	-	-	-	-	-	-	-
8GBK □ BMH/BH		-	-	-	-	-	-	-	-	-	-	-	-	-	-	-	-	-	-	-	-	-	-	-	-	-	-	-	-
9GBK □ BMH/BH		-	-	-	-	-	-	-	-	-	-	-	-	-	-	-	-	-	-	-	-	-	-	-	-	-	-	-	-
9PB(F)K □ BMH/BH		-	-	-	-	-	-	-	-	-	-	-	-	-	-	-	-	-	-	-	-	-	-	-	-	-	-	-	-
9HB(F)K □ BMH/BH		-	-	-	-	-	-	-	-	-	-	-	-	-	-	-	-	-	-	-	-	-	-	-	-	-	-	-	-
10UBK □ BH		-	-	-	-	-	-	-	-	-	-	-	-	-	-	-	-	-	-	-	-	-	-	-	-	-	-	-	-

Model	Ratio	15	20	25	30	40	50	60	80	100	120	160	200	225	240
9HC □ □		-	-	-	-	-	-	-	-	-	-	-	-	-	-
10HC □ □		-	-	-	-	-	-	-	-	-	-	-	-	-	-

- not available
- same direction as the motor shaft
- opposite direction from the motor shaft

* In case of using an inter-decimal gearbox, the rotating speed of output shaft will be reduce by 10:1 but the rotating direction is the same as the gearbox's direction.

Gearbox Life Expectancy and Service Factor

- The life expectancy of the gearbox varies depending on load fluctuation and is determined by the 'service factor' based on its load. Service factor is a coefficient that is used to estimate the service life of the gearbox. This value is generally derived from experience and based on the type of load and operating conditions. The standard life can be expected when the product is operated at service factor 1.0. The life of a component during a particular application is estimated by dividing the standard life expectancy by the service factor. For example, if the motor is operating with an ordinary load for 8 continuous hours a day, the service factor is 1.0. Thus, if the operation continues within the permissible torque for the gearbox and within the range of the prescribed temperature (letting the gearbox case temperature stay below 50°C), the life expectancy of the gearbox is 10,000 hours for the ball bearing type and 2,000 hours for the metal type. However, if a ball bearing type of gearbox is operating for 24 hours a day, the service factor becomes 1.5 so that the life expectancy decreases to 1/1.5. Therefore the service factor should be taken into account to select such a motor and a gearbox which have the biggest permissible torque.

● Example of Load and Service Factor

Type of Load	Service Factor			Operation Example
	5 hours/day	8 hours/day	24 hours/day	
Constant	0.8	1.0	1.5	Unidirectional, continuous run
Light impact/Changeable load	1.2	1.5	2.0	Frequent start/stop, reverse
Heavy impact	1.5	2.0	2.5	Very frequent start/stop, reverse

● Standard Life Expectancy

Ball Bearing Type*	5,000 hours
Metal Bearing Type	2,000 hours

* 5,000 hours when used on reversible motor

Overhung Load and Thrust Load

- The overhung load is defined as a load applied to the output shaft in the right-angle direction. This load is generated when the gearbox is coupled to the machine using a chain, belt, etc., but not when the gearbox is directly connected to the coupling. The thrust load is defined as a load applied to the output shaft of the gearbox in the axial direction.

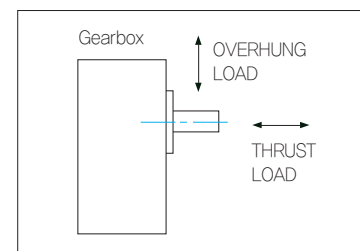

- Since the overhung load exerts a load directly on the bearing, it affects the life span of the gearbox. The overhung load can be calculated from the following equation.

$$W = \frac{K \times T \times f}{r} \quad [\text{kg}]$$

W: Overhung load [kg]
K: Weight coefficient by driving method
T: Delivery force of a gearbox output shaft [kgfcm]
f: Service factor
r: Effective radius of gear, pulley, etc. [cm]

Load Coefficient by Driving Method

Driving Method	K
Chain, Sprocket	1
Gear	1.25
V-Belt	1.5
Flat Belt	2.5

D Gearbox

Technical Data of Gearbox

- If the motor operates with the calculated overhung load exceeding the maximum allowable value in the below table, the output shaft may bend and fatigue deformation may occur due to the repeated load. So consider it and take care in sizing.

Model	Gear Ratio	Maximum Permissible Torque (kgfcm)	Permissible Overhung Load (kg)	Permissible Thrust Load(kg)
6GBD □ MH	3 ~ 18	1~7	6	3
	25~250	7~30	15	
7GBK □ BMH	3 ~ 18	1~18	10	4
	20 ~ 200	5~50	20	
8GBK □ BMH	3 ~ 18	2~46	12	5
	20 ~ 360	13~80	24	
9GBK □ BMH	2 ~ 18	4~42	30	10
	20 ~ 200	36~100	37	
9PBK □ BH 9PFK □ BH	2 ~ 10	4~70	45	15
	12.5 ~ 20	22~126	52	
	25 ~ 200	40~200	60	
9HBK □ BH/9HFK □ BH	3 ~ 200	9~300	55	20
10UBK □ BH	3 ~ 60	45~400	55	
	90 ~ 180	400	65	
8WD □ BL/BR/BRL	10 ~ 18	8~42	8	-
	25 ~ 60	16~60	15	
9WD □ BL/BR/BRL	10 ~18	20~115	20	-
	25 ~ 60	43~122	25	
9WHD □ -030	5~80	13~205	100	-
9WHD □ -040	50 ~ 100	230~350	170	-
10WHD □ -040	5 ~ 40	65~395		-
9HC □ □	15~60	60~656	220	-
	80~240	320~1800	320	-
10HC □ □	15~60	200~1067	280	-
	80~240	1067~3000	380	-

- In case the calculated overhung load value exceeds the allowable value above, please set up the structure of the motor as shown in the picture to withstand the overhung load.
- Also, if a load should be directly imposed on the output shaft, please place the load as near to the gearbox as possible to avoid the one-sided load.
- In case a helical gear or a worm gear is employed as an output delivery mechanism, make sure not to exceed both the overhung load and the thrust load simultaneously.

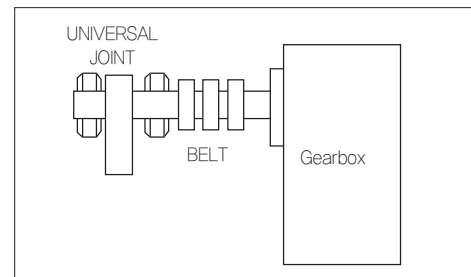

Backlash Noise of Gearbox

Operating Noise of Gearbox

The backlash noise can be indicated by operating noise value. DKM Gearbox's operating noise is like below.

Frame Size	Limit of Operating
70mm	40dB
80mm	42dB
90mm	49dB

Reference

- Operating noise value is measured at a distance of 1m from the side of the gearbox.
- dB (decibel) is a unit of measurement which is used to indicate how loud a sound is.
- Level of operating noise (Ref. value)
 - 20dB --- The sound of shaking leaves
 - 30dB --- The sound in suburb of city in night time
 - 40dB --- The sound in a silent park
 - 50dB --- The sound in a silent office

☉ The Check Point of Gearbox Noise

- **Noise under No Load**

The backlash noise depends on the situation of load. For example, in case of rotation at no load, gear could pop and crash between them therefore there could be little vibration and it could cause noise. This noise can be restrained and controlled by carrying some friction load.

- **Noise when mounted with load**

If a gearbox is not mounted on the bracket properly, there could be some noise by vibration caused by eccentric force. In this case, please check the mounting position.

- **Noise of Damaged Gear**

When attaching a gearbox to a motor, users have to turn the gearbox slowly according to the shape of the pinion. Otherwise, the gear could get damaged by the effect of overloading sequences. Also, there might be abnormal noise in the gearbox. So please handle the gearbox with special care in assembly.

☉ Assembly Method of Motor and Gearbox

- To assemble the motor and the gearbox, adjust the assembling faces together in such a way as shown in the figure on the right and turn slowly to complete the assembly. When doing the assembly, special care should be taken neither to exert excessive force on the motor shaft nor to hit the inside of the gearbox. Otherwise, the gear will get damaged, resulting in an abnormal noise and a shortened lifetime of the motor.

- Use the provided mounting screws for assembly of the gearbox and the motor, and tighten the screws correctly. Be sure there is no-gab between motor flange, the gearbox surface and the mounting surface.

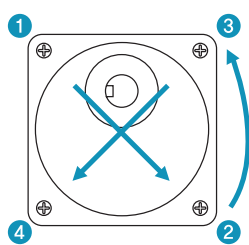
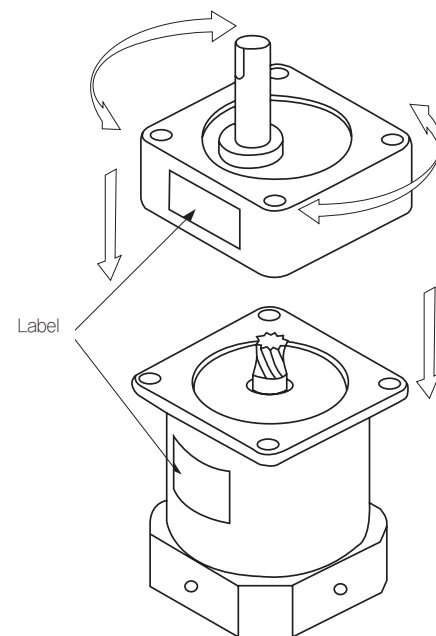

Correct

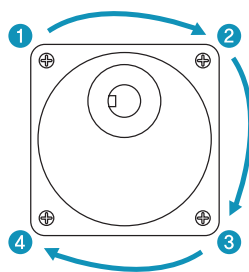

Wrong

D Gearbox

Parallel Gearbox

GType General Box Type Gearbox

Frame Size 60mm Model: 6GBD □ MH – Max. Permissible Torque

* These are reference figures when the gearbox is attached to the induction motor.

Motor Output	Gear Ratio		3	3.6	5	6	7.5	9	10	12.5	15	18	20	25	30	36	40	50	60	75	90	100	120	150	180	200	250
	60Hz	r/min	600	500	360	300	240	200	180	144	120	100	90	72	60	50	45	36	30	24	20	18	15	12	10	9	7.2
	50Hz	r/min	500	417	300	250	200	166	150	120	100	83	75	60	50	41	37	30	25	20	16	15	12	10	8	7.5	6
6W	60Hz	kgfcm	0.9	1.1	1.5	1.8	2.3	2.7	3.1	3.8	4.6	5.5	5.5	6.9	8.3	9.9	11.0	12.4	14.9	18.7	22.4	24.9	30.0	30.0	30.0	30.0	30.0
	50Hz	kgfcm	1.2	1.4	2.0	2.4	3.0	3.6	3.9	4.9	5.9	7.1	7.1	8.9	10.7	12.8	14.2	16.1	19.3	24.1	28.9	30.0	30.0	30.0	30.0	30.0	30.0

1) Enter the gear ratio in the box (□) within the gearbox model name.

2) A colored background indicates the gear shaft rotation in the same direction as the motor shaft; a white background indicates the rotation in the opposite direction.

3) The rotating speed is calculated by dividing the motor's synchronous speed (50Hz: 1,500r/min, 60Hz: 1,800r/min) by the gear ratio.

The actual speed is 2~20% less than the displayed value, depending on the size of the load.

4) Calculation of N.m = kgfcm X 0.98

Dimensions

● Model: 6GBD □ MH

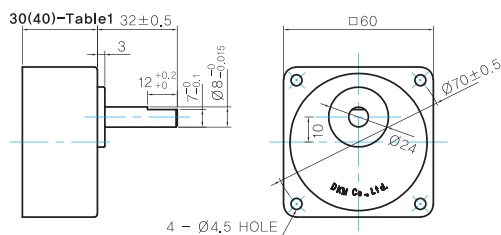

● GEARBOX OUTPUT SHAFT

MODEL	SPEC
D-CUT TYPE	

● KEY SPEC

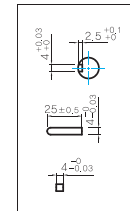

● 30(40)-Table1

SIZE(mm)	GEAR RATIO
30	6GBD3MH - 6GBD18MH
40	6GBD20MH - 6GBD250MH

WEIGHT

Model	WEIGHT(Kg)
6GBD3MH ~ 6GBD18MH	0.3
6GBD20MH ~ 6GBD40MH	0.32
6GBD50MH ~ 6GBD250MH	0.34

Frame Size 70mm Model: 7GBK □ BMH – Max. Permissible Torque

* These are reference figures when the gearbox is attached to the induction motor.

Motor Output	Gear Ratio		3	3.6	5	6	7.5	9	10	12.5	15	18	20	25	30	36	40	50	60	75	90	100	120	150	180	200
	60Hz	r/min	600	500	360	300	240	200	180	144	120	100	90	72	60	50	45	36	30	24	20	18	15	12	10	9
	50Hz	r/min	500	417	300	250	200	167	150	120	100	83	75	60	50	42	38	30	25	20	17	15	12.5	10	8	7.5
6W	60Hz	kgfcm	0.9	1.1	1.5	1.8	2.2	2.7	3.0	3.7	4.4	5.3	5.3	6.7	8.0	9.6	10.7	12.1	14.5	18.1	21.7	24.1	28.9	36.2	43.4	48.2
	50Hz	kgfcm	1.1	1.3	1.8	2.2	2.7	3.3	3.6	4.6	5.5	6.6	6.6	8.2	9.8	11.8	13.1	14.8	17.8	22.3	26.7	29.7	35.6	44.5	50.0	50.0
10W	60Hz	kgfcm	1.5	1.8	2.5	3.1	3.8	4.6	5.1	6.4	7.6	9.2	9.2	11.5	13.8	16.5	18.3	20.7	24.9	31.1	37.3	41.5	49.8	50.0	50.0	50.0
	50Hz	kgfcm	2.0	2.4	3.3	3.9	4.9	5.9	6.6	8.2	9.9	11.8	11.9	14.8	17.8	21.3	23.7	26.8	32.1	40.2	48.2	50.0	50.0	50.0	50.0	50.0
15W	60Hz	kgfcm	2.2	2.7	3.7	4.4	5.5	6.7	7.4	9.2	11.1	13.3	13.3	16.7	20.0	24.0	26.7	30.1	36.2	45.2	50.0	50.0	50.0	50.0	50.0	50.0
	50Hz	kgfcm	3.0	3.6	4.9	5.9	7.4	8.9	9.9	12.3	14.8	17.8	17.8	22.2	26.7	32.0	35.6	40.2	48.2	50.0	50.0	50.0	50.0	50.0	50.0	50.0

1) Enter the gear ratio in the box (□) within the gearbox model name.

2) A colored background indicates the gear shaft rotation in the same direction as the motor shaft; a white background indicates the rotation in the opposite direction.

3) The rotating speed is calculated by dividing the motor's synchronous speed (50Hz: 1,500r/min, 60Hz: 1,800r/min) by the gear ratio.

The actual speed is 2~20% less than the displayed value, depending on the size of the load.

4) Calculation of N.m = kgfcm X 0.98

Dimensions

● Model: 7GBK□BMH

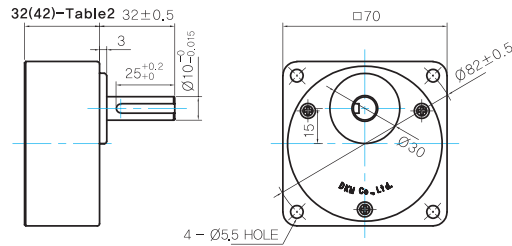

● GEARBOX OUTPUT SHAFT

MODEL	SPEC
KEY TYPE	

● KEY SPEC

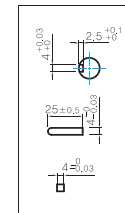

● 32(42)-Table2

SIZE(mm)	GEAR RATIO
32	7GBK3BMH - 7GBK18BMH
42	7GBK20BMH - 7GBK200BMH

● WEIGHT

Model	WEIGHT(Kg)
7GBK3BMH ~ 7GBK18BMH	0,38
7GBK20BMH ~ 7GBK40BMH	0,48
7GBK50BMH ~ 7GBK200MH	0,53

Frame Size 80mm Model: 8GBK □ BMH Max. Permissible Torque

* These are reference figures when the gearbox is attached to the induction motor.

Motor Output	Gear Ratio		3	3.6	5	6	7.5	9	10	12.5	15	18	20	25	30
	60Hz	50Hz	r/min												
15W	60Hz	kgfcm	2.2	2.7	3.7	4.4	5.5	6.7	7.4	9.2	11.1	13.3	13.3	16.7	20.0
	50Hz		2.6	3.2	4.4	5.3	6.6	7.9	8.8	11.0	13.1	15.8	15.8	19.8	23.7
25W	60Hz		3.7	4.4	6.2	7.4	9.2	11.1	12.3	15.4	18.5	22.2	22.2	27.8	33.3
	50Hz		4.4	5.3	7.3	8.8	11.0	13.1	14.6	18.3	21.9	26.3	26.3	32.9	39.5
40W	60Hz		6.1	7.3	10.2	12.2	15.3	18.4	20.4	25.5	30.6	36.7	36.8	46.0	55.2
	50Hz		7.6	9.1	12.6	15.2	19.0	22.7	25.3	31.6	37.9	45.5	45.6	56.9	68.3

Motor Output	Gear Ratio		36	40	50	60	75	90	100	120	150	180	200	250	300	360	
	60Hz	50Hz	r/min														
15W	60Hz	kgfcm	24.0	26.7	30.1	36.2	45.2	54.2	60.3	72.3	80.0	80.0	80.0	80.0	80.0	80.0	80.0
	50Hz		42	37.5	30	25	20	17	15	12.5	10	8	7.5	6	5	4	
25W	60Hz		28.4	31.6	35.7	42.9	53.6	64.3	71.4	80.0	80.0	80.0	80.0	80.0	80.0	80.0	80.0
	50Hz		47.4	52.7	59.5	80.0	80.0	80.0	80.0	80.0	80.0	80.0	80.0	80.0	80.0	80.0	80.0
40W	60Hz		66.2	73.6	80.0	80.0	80.0	80.0	80.0	80.0	80.0	80.0	80.0	80.0	80.0	80.0	80.0
	50Hz		80.0	80.0	80.0	80.0	80.0	80.0	80.0	80.0	80.0	80.0	80.0	80.0	80.0	80.0	80.0

1) Enter the gear ratio in the box (□) within the gearbox model name.

2) A colored background indicates the gear shaft rotation in the same direction as the motor shaft; a white background indicates the rotation in the opposite direction.

3) The rotating speed is calculated by dividing the motor's synchronous speed (50Hz: 1,500r/min, 60Hz: 1,800r/min) by the gear ratio.

The actual speed is 2~20% less than the displayed value, depending on the size of the load.

4) Calculation of N.m ≅ kgfcm X 0.98

Dimensions

● Model: 8GBK□BMH

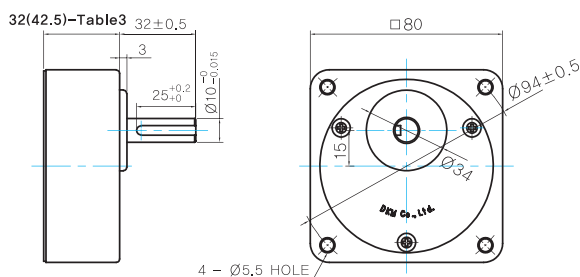

● GEARBOX OUTPUT SHAFT

MODEL	SPEC
KEY TYPE	

● KEY SPEC

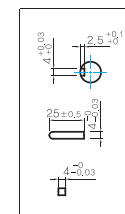

● 32(42.5)-Table3

SIZE(mm)	GEAR RATIO
32	8GBK3BMH - 8GBK18BMH
42.5	8GBK20BMH - 8GBK360BMH

● WEIGHT

Model	WEIGHT(Kg)
8GBK3BMH ~ 8GBK18BMH	0,56
8GBK20BMH ~ 8GBK40BMH	0,65
8GBK50BMH ~ 8GBK360BMH	0,72

D Gearbox

Parallel Gearbox

Frame Size 90mm Model: 9GBK □ BMH – Max. Permissible Torque

* These are reference figures when the gearbox is attached to the induction motor.

Motor Output	Gear Ratio	Gear Ratio																								
		2	3	3.6	5	6	7.5	9	10	12.5	15	18	20	25	30	36	40	50	60	75	90	100	120	150	180	200
40W	60Hz	900	600	500	360	300	240	200	180	144	120	100	90	72	60	50	45	36	30	24	20	18	15	12	10	9
	50Hz	750	500	417	300	250	200	167	150	120	100	83	75	60	50	42	38	30	25	20	17	15	13	10	8	7
40W	60Hz	3.9	5.9	7.1	9.9	11.8	14.8	17.8	19.7	24.7	29.6	35.5	35.6	44.4	53.3	64.0	71.1	80.4	96.4	100.0	100.0	100.0	100.0	100.0	100.0	100.0
	50Hz	4.7	7.0	8.4	11.7	14.0	17.5	21.0	23.4	29.2	35.1	42.1	42.1	52.7	63.2	75.8	84.3	95.2	100.0	100.0	100.0	100.0	100.0	100.0	100.0	100.0

- 1) Enter the gear ratio in the box (□) within the gearbox model name.
- 2) A colored background indicates the gear shaft rotation in the same direction as the motor shaft; a white background indicates the rotation in the opposite direction.
- 3) The rotating speed is calculated by dividing the motor's synchronous speed (50Hz: 1,500r/min, 60Hz: 1,800r/min) by the gear ratio. The actual speed is 2~20% less than the displayed value, depending on the size of the load.
- 4) Calculation of N,m ≒ kgfcm X 0.98

Dimensions

● Model: 9GBK □ BMH

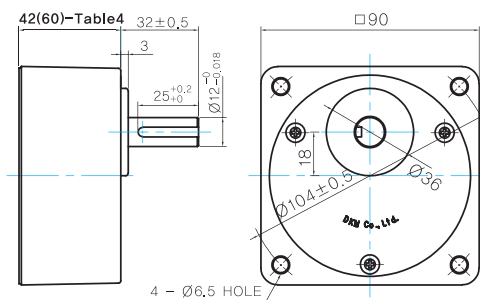

● GEARBOX OUTPUT SHAFT

MODEL	SPEC
KEY TYPE	

● KEY SPEC

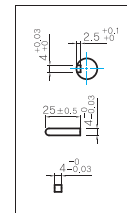

● 42(60)-Table4

SIZE(mm)	GEAR RATIO
42	9GBK2BMH - 9GBK18BMH
60	9GBK20BMH - 9GBK200BMH

WEIGHT

Model	WEIGHT(Kg)
9GBK2BMH ~ 9GBK18BMH	0.78
9GBK20BMH ~ 9GBK40BMH	1.1
9GBK50BMH ~ 9GBK200BMH	1.2

Gearbox Image



P Type

Powerful Box / Flange Type Gearbox

Dimensions

- Model: 9PBK □ BH

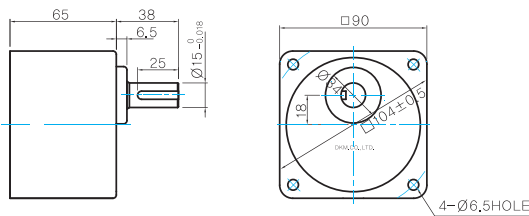

- Model: 9PFK □ BH

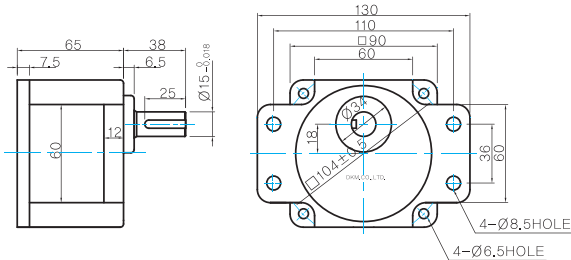

- MOTOR OUTPUT SHAFT

MODEL	SPEC
KEY TYPE	

- KEY SPEC

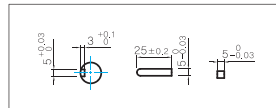

- WEIGHT

Model	WEIGHT(Kg)
9PB(F)K2BH - 9PB(F)K10BH	1,28
9PB(F)K12.5BH - 9PB(F)K20BH	1,3
9PB(F)K25BH - 9PB(F)K60BH	1,45
9PB(F)K75BH - 9PB(F)K200BH	1,47

Gearbox Images



9PBK □ BH/9PFK □ BH - Max. Permissible Torque

* These are reference figures when the gearbox is attached to the induction motor.

Motor Output	Gear Ratio		2	3	3.6	5	6	7.5	9	10	12.5	15	18	20	25
	60Hz	50Hz	900	600	500	360	300	240	200	180	144	120	100	90	72
		r/min													
40W	60Hz	kgfcm	3.9	5.9	7.1	9.9	11.8	14.8	17.8	19.7	22.2	26.7	32.0	35.6	40.2
	50Hz		4.7	7.0	8.4	11.7	14.0	17.5	21.0	23.4	26.3	31.6	37.9	42.1	47.6
60W	60Hz		5.9	8.9	10.7	14.8	17.8	22.2	26.6	29.6	33.3	40.0	48.0	53.3	60.3
	50Hz		7.0	10.5	12.6	17.5	21.0	26.3	31.6	35.1	39.5	47.4	56.9	63.2	71.4
90W	60Hz		8.9	13.3	16.0	22.2	26.6	33.3	39.9	44.4	50.0	60.0	72.0	80.0	90.4
	50Hz		10.5	15.8	18.9	26.3	31.6	39.4	47.3	52.6	59.3	71.1	85.3	94.8	107.1
120W	60Hz		11.8	17.8	21.3	29.6	35.5	44.4	53.3	59.2	66.7	80.0	96.0	106.7	120.5
	50Hz		14.0	21.0	25.2	35.1	42.1	52.6	63.1	70.1	79.0	94.8	113.8	126.4	142.9

Motor Output	Gear Ratio		30	36	40	50	60	75	90	100	120	150	180	200
	60Hz	50Hz	60	50	45	36	30	24	20	18	15	12	10	9
		r/min												
40W	60Hz	kgfcm	48.2	57.9	64.3	80.4	96.4	107.7	129.3	143.7	172.4	200.0	200.0	200.0
	50Hz		57.1	68.6	76.2	95.2	114.3	127.7	153.2	170.3	200.0	200.0	200.0	200.0
60W	60Hz		72.3	86.8	96.4	120.5	144.6	161.6	193.9	200.0	200.0	200.0	200.0	200.0
	50Hz		85.7	102.9	114.3	142.9	171.4	191.6	200.0	200.0	200.0	200.0	200.0	200.0
90W	60Hz		108.5	130.2	144.6	180.8	200.0	200.0	200.0	200.0	200.0	200.0	200.0	200.0
	50Hz		128.6	154.3	171.4	200.0	200.0	200.0	200.0	200.0	200.0	200.0	200.0	200.0
120W	60Hz		144.6	173.6	192.9	200.0	200.0	200.0	200.0	200.0	200.0	200.0	200.0	200.0
	50Hz		171.4	200.0	200.0	200.0	200.0	200.0	200.0	200.0	200.0	200.0	200.0	200.0

1) Enter the gear ratio in the box (□) within the gearbox model name.

2) A colored background indicates the gear shaft rotation in the same direction as the motor shaft; a white background indicates the rotation in the opposite direction.

3) The rotating speed is calculated by dividing the motor's synchronous speed (50Hz: 1,500r/min, 60Hz: 1,800r/min) by the gear ratio.

The actual speed is 2~20% less than the displayed value, depending on the size of the load.

4) Calculation of N.m \approx kgfcm X 0.98

D Gearbox

Parallel Gearbox

H Type High Powerful Box / Flange Type Gearbox

Dimensions

● Model: 9HBK□BH

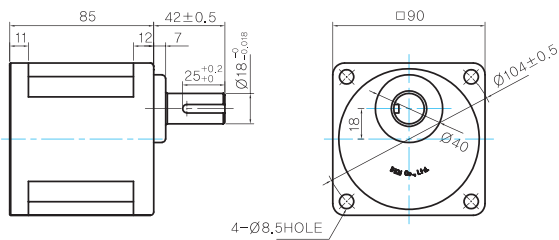

● Model: 9HFK□BH

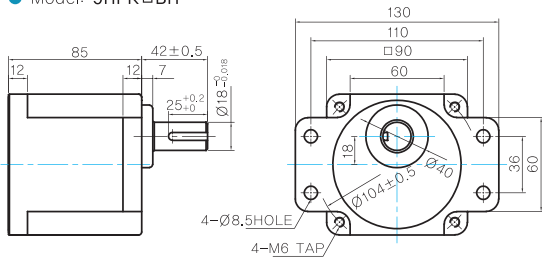

● MOTOR OUTPUT SHAFT

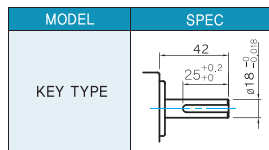

● KEY SPEC

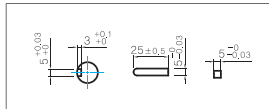

● WEIGHT

Model	WEIGHT (Kg)
9HB(F)K3BH ~ 9HB(F)K10BH	1.62
9HB(F)K12.5BH ~ 9HB(F)K20BH	1.68
9HB(F)K25BH ~ 9HB(F)K60BH	1.73
9HB(F)K75BH ~ 9HB(F)K200BH	1.78

Gearbox Images

9HBK□BH



9HFK□BH



9HBK□BH/9HFK□BH – Max. Permissible Torque

* These are reference figures when the gearbox is attached to the induction motor.

Motor Output	Gear Ratio	3	3.6	5	6	7.5	9	10	12.5	15	18	20	25	30	36	40	50	60	75	90	100	120	150	180	200	r/min		
																										60Hz	50Hz	
60W	60Hz	600	500	360	300	240	200	180	144	120	100	90	72	60	50	45	36	30	24	20	18	15	12	10	9	600	500	
	50Hz	500	417	300	250	200	167	150	120	100	83	75	60	50	42	37.5	30	25	20	17	15	12.5	10	8	7.5	300.0	300.0	
90W	60Hz	8.9	10.7	14.8	17.8	22.2	26.6	29.6	33.3	40.0	48.0	53.3	60.3	72.3	86.8	96.4	120.5	144.6	161.6	193.9	215.5	258.6	300.0	300.0	300.0	300.0	300.0	300.0
	50Hz	10.5	12.6	17.5	21.0	26.3	31.6	35.1	39.5	47.4	56.9	63.2	71.4	85.7	102.9	114.3	142.9	171.4	191.6	229.9	255.4	300.0	300.0	300.0	300.0	300.0	300.0	
120W	60Hz	13.3	16.0	22.2	26.6	33.3	39.9	44.4	50.0	60.0	72.0	80.0	90.4	108.5	130.2	144.6	180.8	217.0	242.4	290.9	300.0	300.0	300.0	300.0	300.0	300.0	300.0	300.0
	50Hz	15.8	18.9	26.3	31.6	39.4	47.3	52.6	59.3	71.1	85.3	94.8	107.1	128.6	154.3	171.4	214.3	257.1	287.3	300.0	300.0	300.0	300.0	300.0	300.0	300.0	300.0	
150W	60Hz	17.8	21.3	29.6	35.5	44.4	53.3	59.2	66.7	80.0	96.0	106.7	120.5	144.6	173.6	192.9	241.1	289.3	300.0	300.0	300.0	300.0	300.0	300.0	300.0	300.0	300.0	300.0
	50Hz	21.0	25.2	35.1	42.1	52.6	63.1	70.1	79.0	94.8	113.8	126.4	142.9	171.4	205.7	228.6	285.7	300.0	300.0	300.0	300.0	300.0	300.0	300.0	300.0	300.0	300.0	
180W	60Hz	22.9	27.5	38.2	45.8	57.3	68.7	76.3	86.0	103.2	123.9	137.6	155.5	186.6	224.0	248.8	300.0	300.0	300.0	300.0	300.0	300.0	300.0	300.0	300.0	300.0	300.0	300.0
	50Hz	27.3	32.8	45.5	54.6	68.3	81.9	91.0	102.6	123.1	147.7	164.1	185.4	222.5	267.0	296.7	300.0	300.0	300.0	300.0	300.0	300.0	300.0	300.0	300.0	300.0	300.0	
200W	60Hz	26.6	32.0	44.4	53.3	66.6	79.9	88.8	100.0	120.0	144.0	160.0	180.8	217.0	260.4	289.3	300.0	300.0	300.0	300.0	300.0	300.0	300.0	300.0	300.0	300.0	300.0	300.0
	50Hz	32.8	39.3	54.6	65.5	81.9	98.3	109.2	123.1	147.7	177.2	196.9	222.5	267.0	300.0	300.0	300.0	300.0	300.0	300.0	300.0	300.0	300.0	300.0	300.0	300.0	300.0	
200W	60Hz	30.5	36.6	50.9	61.1	76.3	91.6	101.8	114.7	137.6	165.1	183.5	207.4	248.8	298.6	300.0	300.0	300.0	300.0	300.0	300.0	300.0	300.0	300.0	300.0	300.0	300.0	300.0
	50Hz	36.4	43.7	60.7	72.8	91.0	109.2	121.4	136.7	164.1	196.9	218.8	247.2	296.7	300.0	300.0	300.0	300.0	300.0	300.0	300.0	300.0	300.0	300.0	300.0	300.0	300.0	

1) Enter the gear ratio in the box (□) within the gearbox model name.

2) A colored background indicates the gear shaft rotation in the same direction as the motor shaft: a white background indicates the rotation in the opposite direction.

3) The rotating speed is calculated by dividing the motor's synchronous speed (50Hz: 1,500r/min, 60Hz: 1,800r/min) by the gear ratio. The actual speed is 2~20% less than the displayed value, depending on the size of the load.

4) Calculation of N.m ≈ kgfcm X 0.98

U Type Ultra Powerful Box / Type Gearbox

Dimensions

Model: 10UBK□BH

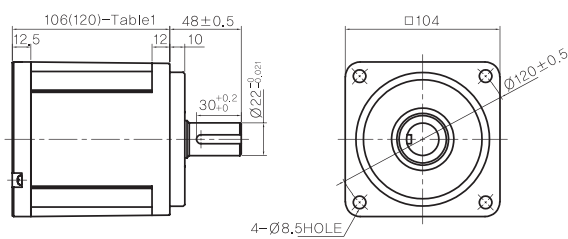

MOTOR OUTPUT SHAFT

MODEL	SPEC
KEY TYPE	<h3>KEY SPEC</h3>

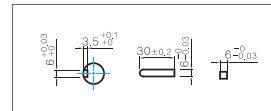

WEIGHT

	PART	WEIGHT(Kg)
GEAR BOX	10UBK3BH ~ 10UBK9BH	2,0
	10UBK10BH ~ 10UBK15BH	2,15
	10UBK20BH ~ 10UBK60BH	2,3
	10UBK90BH ~ 10UBK180BH	2,5

Gearbox Images



10UBK□BH – Max. Permissible Torque

400W 3Φ 60HZ

Motor Model	Gearbox Model	Gear Ratio r/min	3	5	9	10	15	20	25	30	40	50	60	90	100	120	150	180
			kgfcm N.m	600	360	200	180	120	90	72	60	45	36	30	20	18	15	12
10IDG6-400FU-T	10UBK□BH	kgfcm N.m	60 5.88	100 9.8	180 17.6	185 18.1	275 26.7	300 29.4	300 29.4	300 29.4	350 34.3	350 34.3	400 39.2	400 39.2	400 39.2	400 39.2	400 39.2	400 39.2

300W 1Φ 60HZ

Motor Model	Gearbox Model	Gear Ratio r/min	3	5	9	10	15	20	25	30	40	50	60	90	100	120	150	180
			kgfcm N.m	600	360	200	180	120	90	72	60	45	36	30	20	18	15	12
10IDGD-300FU-T & 10IDG8-300FU-T	10UBK□BH	kgfcm N.m	45 4.41	75 7.35	135 13.2	140 13.7	205 20.1	250 24.5	300 29.4	300 29.4	350 34.3	350 34.3	400 39.2	400 39.2	400 39.2	400 39.2	400 39.2	400 39.2

300W 3Φ 50HZ

Motor Model	Gearbox Model	Gear Ratio r/min	3	5	9	10	15	20	25	30	40	50	60	90	100	120	150	180
			kgfcm N.m	500	300	167	150	100	75	60	50	37.5	30	25	16.7	15	12.5	10
10IDG7-300FU-T & 10IDG8-300FU-T	10UBK□BH	kgfcm N.m	55 5.39	95 9.31	170 16.7	170 16.7	250 24.5	300 29.4	300 29.4	300 29.4	350 34.3	350 34.3	400 39.2	400 39.2	400 39.2	400 39.2	400 39.2	400 39.2

250W 1Φ 50HZ

Motor Model	Gearbox Model	Gear Ratio r/min	3	5	9	10	15	20	25	30	40	50	60	90	100	120	150	180
			kgfcm N.m	50	80	145	150	220	270	335	400	400	400	400	400	400	400	400
10IDGE-250FU-T	10UBK□BH	kgfcm N.m	50 4.9	80 7.84	145 14.2	150 14.7	220 21.6	270 26.5	335 32.8	400 39.2	400 39.2	400 39.2	400 39.2	400 39.2	400 39.2	400 39.2	400 39.2	400 39.2

1. 10IDG6-400F : 3Phase 220/380V 60Hz 2. 10IDG7-300F : 3Phase 230/400V 50Hz
3. 10IDG8-300F : 3Phase 440V 50/60Hz 4. 10IDGE-250F : 1Phase 220~240V 50Hz 5. 10IDGD-300F : 1Phase 220V 60Hz

D Gearbox

Right-Angle Gearbox

W Type

Worm Solid Type Gearbox

Dimensions

Model: 8WD□BL/BR/BRL

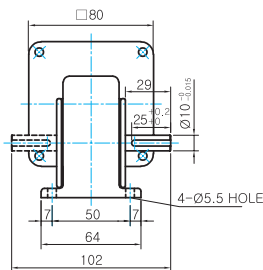
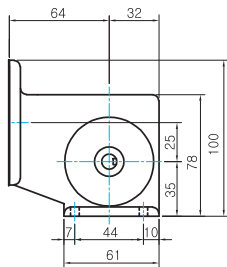

KEY SPEC

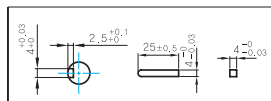

WEIGHT

Model	WEIGHT(Kg)
8WD□BL/BR/BRL	0.68

Dimensions

Model: 9WD□BL/BR/BRL

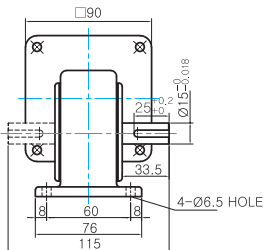
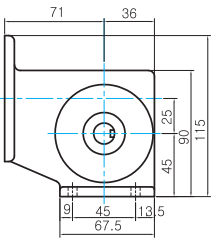

KEY SPEC

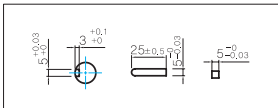

WEIGHT

Model	WEIGHT(Kg)
9WD□BL/BR/BRL	1.0

8WD □ BL/ □ BR/ □ BRL Max. Permissible Torque

* These are reference figures when the gearbox is attached to the induction motor.

Motor Output	Gear Ratio		10	12	15	18	25	30	36	50	60
	60Hz	r/min	180	150	120	100	72	60	50	36	30
15W	60Hz	kgfcm	7.5	8.8	10.5	12.2	16.0	18.1	21.0	27.4	30.1
	50Hz		8.9	10.4	12.5	14.4	18.9	21.4	24.9	32.5	35.7
25W	60Hz		12.5	14.6	17.6	20.3	26.6	30.1	35.1	45.7	50.2
	50Hz		14.8	17.3	20.8	24	31.6	35.7	41.6	54.1	59.5
40W	60Hz		20.7	24.2	29.1	33.6	44.1	49.9	58.1	60.0	60.0
	50Hz		25.6	30.0	36.0	41.6	54.6	60.0	60.0	60.0	60.0

- 1) Enter the gear ratio in the box (□) within the gearbox model name.
- 2) The rotating speed is calculated by dividing the motor's synchronous speed (50Hz: 1,500r/min, 60Hz: 1,800r/min) by the gear ratio. The actual speed is 2~20% less than the displayed value, depending on the size of the load.
- 3) Calculation of N.m ≈ kgfcm X 0.98

9WD □ BL/ □ BR/ □ BRL Max. Permissible Torque

* These are reference figures when the gearbox is attached to the induction motor.

Motor Output	Gear Ratio		10	12	15	18	25	30	36	50	60
	60Hz	r/min	180	150	120	100	72	60	50	36	30
40W	60Hz	kgfcm	20.0	23.4	28.1	32.4	42.6	48.2	56.1	73.1	80.4
	50Hz		23.7	27.7	33.3	38.4	50.5	57.1	66.5	86.6	95.2
60W	60Hz		30.0	35.1	42.2	48.7	63.9	72.3	84.2	109.6	120.5
	50Hz		35.5	41.6	50.0	57.7	75.8	85.7	99.7	129.9	122.4
90W	60Hz		44.9	52.6	63.3	73.0	95.9	108.5	126.2	142.9	122.4
	50Hz		53.2	62.3	75.0	86.5	113.6	128.6	149.6	142.9	122.4
120W	60Hz	59.9	70.1	84.4	97.3	127.8	144.6	153.1	142.9	122.4	
	50Hz	71.0	83.1	100.0	115.3	151.5	170.0	153.1	142.9	122.4	

- 1) Enter the gear ratio in the box (□) within the gearbox model name.
- 2) The rotating speed is calculated by dividing the motor's synchronous speed (50Hz: 1,500r/min, 60Hz: 1,800r/min) by the gear ratio. The actual speed is 2~20% less than the displayed value, depending on the size of the load.
- 3) Calculation of N.m ≈ kgfcm X 0.98

Gearbox Images



WH_{Type} Worm Hollow Type Gearbox

Dimensions

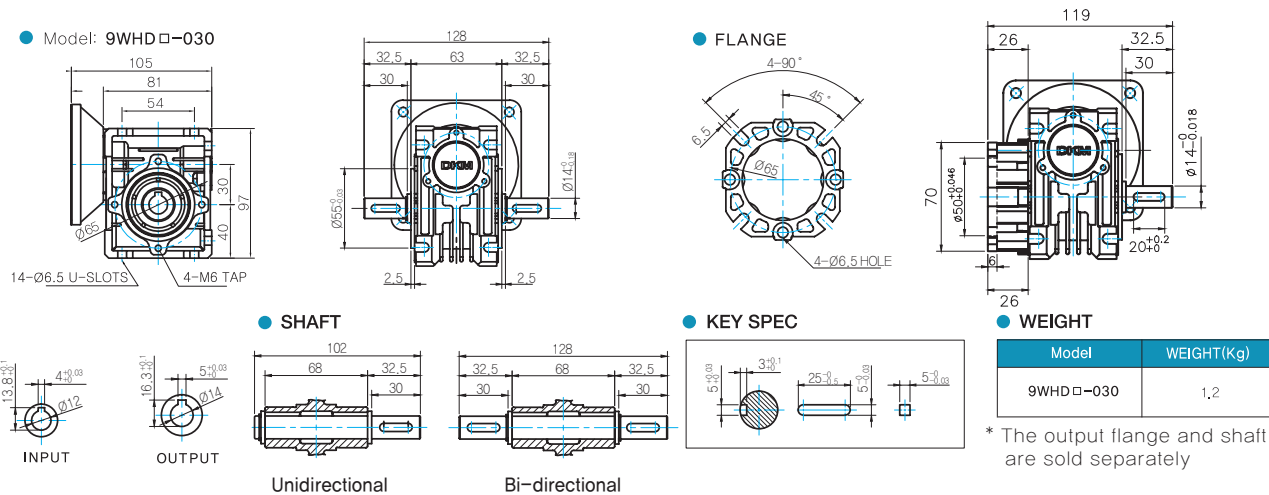

9WHD□-030 Max. Permissible Torque

* These are reference figures when the gearbox is attached to the induction motor.

Motor Output	Gear Ratio		5	7.5	10	15	20	25	30	40	50	60	80
	60Hz	r/min	360	240	180	120	90	72	60	45	36	30	22
60W	60Hz	kgfcm	12.7	18.4	23.7	33.3	42.1	48.2	56.1	69.0	78.9	87.7	102.9
	50Hz		15.1	21.8	28.1	39.5	49.9	57.1	66.5	81.7	93.5	103.9	121.9
90W	60Hz		19.1	27.6	35.5	50.0	63.1	72.3	84.2	103.4	118.3	131.5	132.7
	50Hz		22.6	32.7	42.1	59.2	74.8	85.7	99.7	122.6	140.3	155.8	132.7
120W	60Hz		25.4	36.8	47.3	66.6	84.2	96.4	112.2	137.9	157.8	163.3	132.7
	50Hz		30.1	43.6	56.1	79.0	99.7	114.3	133.0	163.5	173.5	163.3	132.7
150W	60Hz		32.8	47.5	61.1	86.0	108.6	124.4	144.8	178.0	173.5	163.3	132.7
	50Hz		39.1	56.6	72.8	102.5	129.5	148.3	172.6	183.7	173.5	163.3	132.7
180W	60Hz		38.1	55.2	71.0	99.9	126.2	144.6	168.3	183.7	173.5	163.3	132.7
	50Hz		46.9	68.0	87.4	123.0	155.4	178.0	204.1	183.7	173.5	163.3	132.7
200W	60Hz		43.7	63.3	81.4	114.6	144.8	165.9	193.0	183.7	173.5	163.3	132.7
	50Hz		52.1	75.5	97.1	136.7	172.6	183.7	204.1	183.7	173.5	163.3	132.7

- 1) Enter the gear ratio in the box (□) within the gearbox model name.
- 2) The rotating speed is calculated by dividing the motor's synchronous speed (50Hz: 1,500r/min, 60Hz: 1,800r/min) by the gear ratio. The actual speed is 2~20% less than the displayed value, depending on the size of the load.
- 3) Calculation of N.m \approx kgfcm X 0.98

Gearbox Image

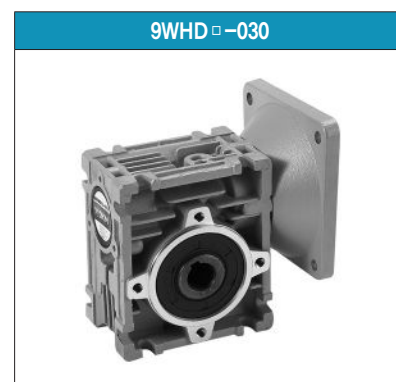

D Gearbox

Right-Angle Gearbox

WH Type

Worm Hollow Type Gearbox

Dimensions

● Model: 9WHD□-040

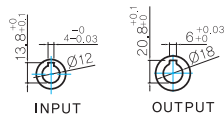
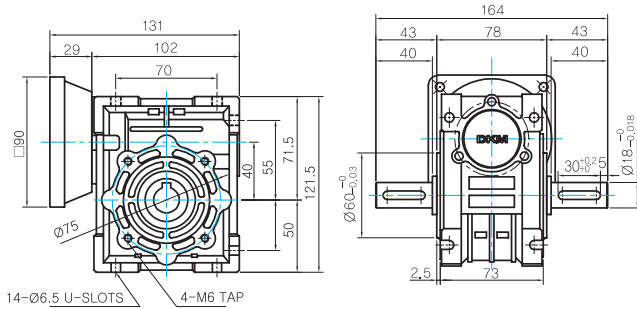

● SHAFT

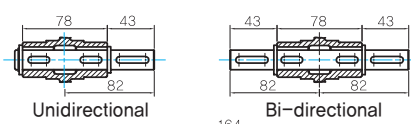

● FLANGE

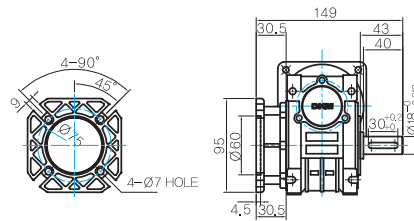

● KEY SPEC

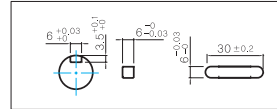

● WEIGHT

Model	WEIGHT(Kg)
9WHD□-040	2,1

* The output flange and shaft are sold separately

● Model: 10WHD□-040

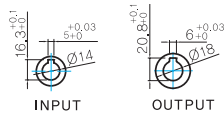
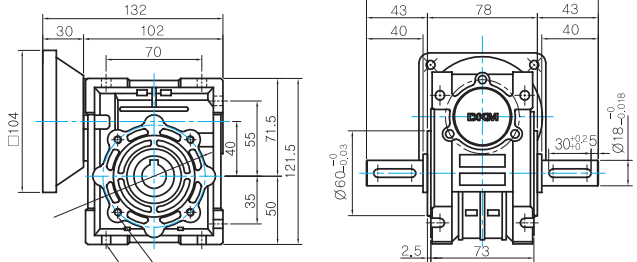

● SHAFT

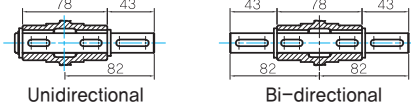

● FLANGE

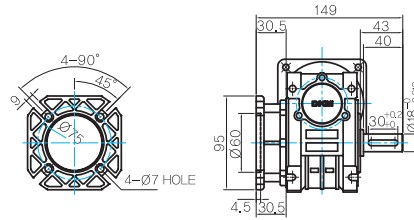

● KEY SPEC

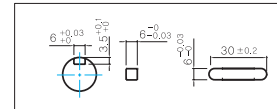

● WEIGHT

Model	WEIGHT(Kg)
10WHD□-040	2,2

* The output flange and shaft are sold separately

9WHD□-040 Max. Permissible Torque

* These are reference figures when the gearbox is attached to the induction motor.

Motor Output	Gear Ratio		50	60	80	100
	60Hz	r/min	30	25	18.75	15
150W	60Hz	kgfcm	230	257.9	295.0	270.0
		N.m	22.54	25.27	28.91	26.46
180W	50Hz	kgfcm	274.2	307.5	295.0	270.0
		N.m	26.87	30.13	28.91	26.46
200W	60Hz	kgfcm	267.4	299.8	295.0	270.0
		N.m	26.20	29.38	28.91	26.46
200W	50Hz	kgfcm	329.1	330.0	295.0	270.0
		N.m	32.25	32.34	28.91	26.46
200W	60Hz	kgfcm	306.7	330.0	295.0	270.0
		N.m	30.05	32.34	28.91	26.46
200W	50Hz	kgfcm	350.0	330.0	295.0	270.0
		N.m	34.30	32.34	28.91	26.46

10WHD□-040 Max. Permissible Torque

* These are reference figures when the gearbox is attached to the induction motor.

Motor Output	Gear Ratio		5	7.5	10	15	20	25	30	40
	Hz	r/min	300	200	150	100	75	60	50	37.5
250W	50Hz	kgfcm	70	100	130	185	240	290	325	305
		N.m	6.85	9.80	12.74	18.18	23.53	28.91	31.76	31.76
300W	60Hz	kgfcm	65	95	125	175	225	270	300	285
		N.m	6.37	9.30	12.25	17.18	22.06	26.46	28.91	27.68
400W	60Hz	kgfcm	80	115	150	215	275	335	375	350
		N.m	7.84	11.25	14.70	21.18	26.91	32.87	36.76	34.30

- 1) Enter the gear ratio in the box (□) within the gearbox model name.
- 2) The rotating speed is calculated by dividing the motor's synchronous speed (50Hz: 1,500r/min, 60Hz: 1,800r/min) by the gear ratio. The actual speed is 2~20% less than the displayed value, depending on the size of the load.
- 3) Calculation of N,m = kgfcm X 0,98

Right-Angle Gearbox

HC Type

Helicross Type Gearbox

Gearbox Image



Right-Angle Gearbox

9HC□-B Max. Permissible Torque

* These are reference figures when the gearbox is attached to the induction motor.

Motor Model	Gear Ratio		15	20	25	30	40	50	60	80	100	120	160	200	225	240
	60Hz	50Hz	r/min													
90W	60Hz	50Hz	120	90	72	60	45	36	30	22.5	18	15	11.25	9	8	7.5
			100	75	60	50	37.5	30	25	18.75	15	12.5	9.4	7.5	6.7	6.3
120W	60Hz	50Hz	60	80	100	120	160	200	240	320	400	480	640	800	900	960
			71.1	94.8	119	142	190	237	284	379	474	569	758	948	1067	1138
150W	60Hz	50Hz	80	107	133	160	213	267	320	427	533	640	853	1067	1200	1280
			94.8	126	158	190	253	316	379	506	632	758	1011	1264	1422	1517
180W	60Hz	50Hz	103	138	172	206	275	344	413	550	688	826	1101	1376	1548	1651
			123	164	205	246	328	410	492	656	820	984	1313	1641	1800	1800
200W	60Hz	50Hz	120	160	200	240	320	400	480	640	800	960	1280	1600	1800	1800
			148	197	246	295	394	492	591	788	984	1181	1575	1800	1800	1800
200W	60Hz	50Hz	138	183	229	275	367	459	550	734	917	1101	1468	1800	1800	1800
			164	219	273	328	438	547	656	875	1094	1313	1750	1800	1800	1800

10HC□-B Max. Permissible Torque

* These are reference figures when the gearbox is attached to the induction motor.

Motor Model	Gear Ratio		15	20	25	30	40	50	60	80	100	120	160	200	225	240
	60Hz	50Hz	r/min													
250W	60Hz	50Hz	120	90	72	60	45	36	30	22.5	18	15	11.25	9	8	7.5
			100	75	60	50	37.5	30	25	18.75	15	12.5	9.4	7.5	6.7	6.3
300W	60Hz	50Hz	213	284	356	427	569	711	853	1138	1422	1706	2275	2844	3000	3000
			200	267	333	400	533	667	800	1067	1333	1600	2133	2666	3000	3000
400W	60Hz	50Hz	246	328	410	492	656	820	984	1313	1641	1969	2625	3000	3000	3000
			267	356	444	533	711	889	1067	1422	1778	2133	2844	3000	3000	3000

- 1) Enter the gear ratio in the box (□) within the gearbox model name.
- 2) The rotating speed is calculated by dividing the motor's synchronous speed (50Hz: 1,500r/min, 60Hz: 1,800r/min) by the gear ratio. The actual speed is 2~20% less than the displayed value, depending on the size of the load.
- 3) Calculation of N.m \approx kgfcm X 0.98

Dimensions (9HC□-B)

- Gear Ratio 1/15~1/60

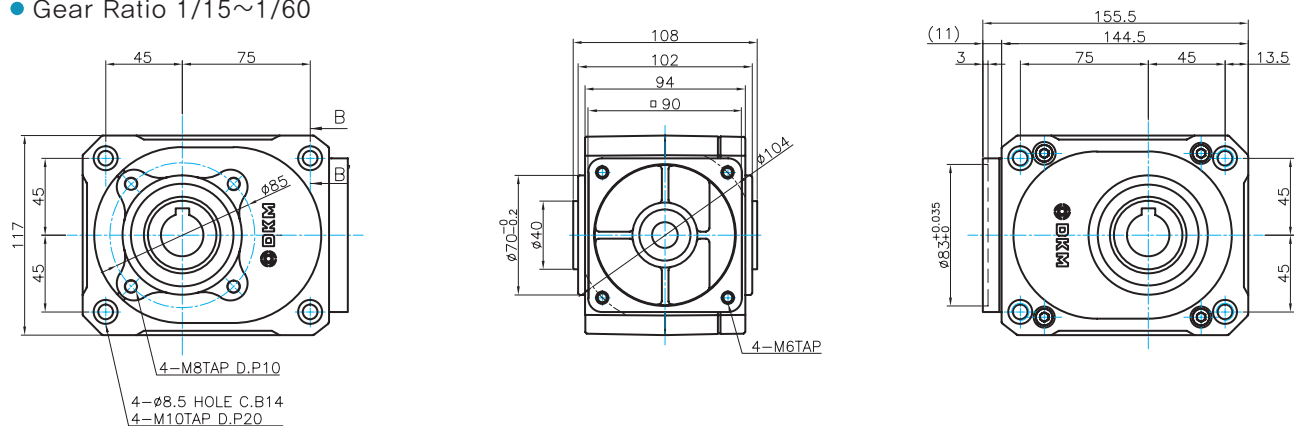

D Gearbox

Right-Angle Gearbox

- Gear Ratio 1/80 ~ 1/240

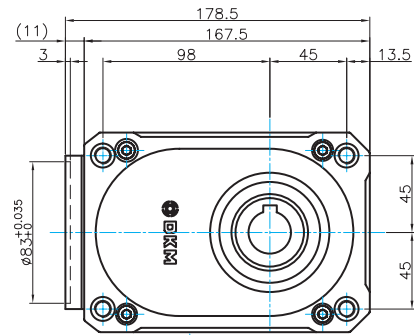
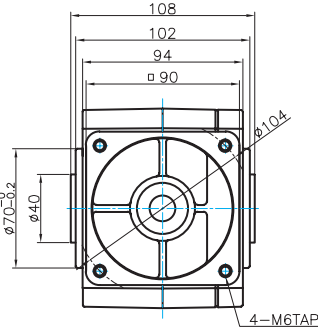
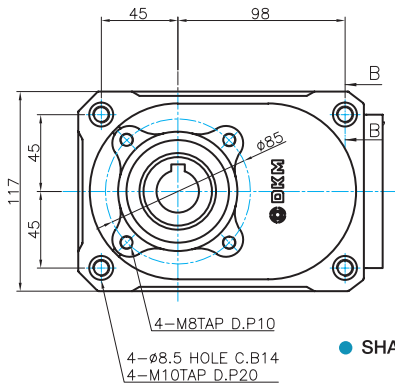

WEIGHT

Model	WEIGHT(Kg)
9HC15-B	4,05
9HC20-B~9HC60-B	4,1
9HC80-B~9HC240-B	4,75

SHAFT

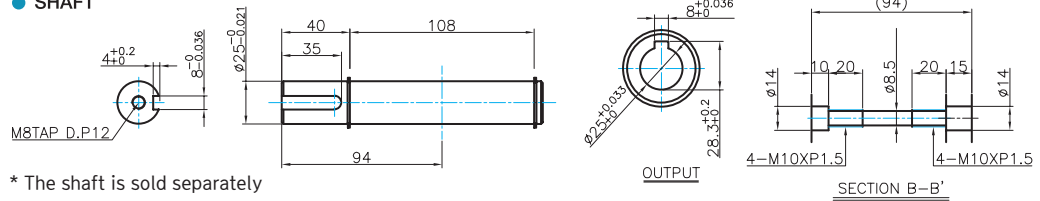

* The shaft is sold separately

Dimensions (10HC□-B)

- Gear Ratio 1/15~1/60

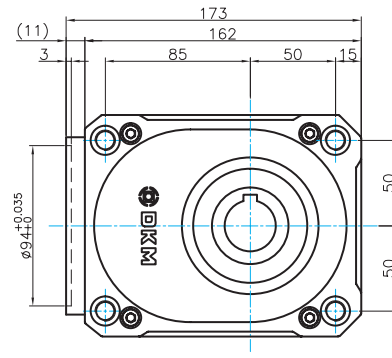
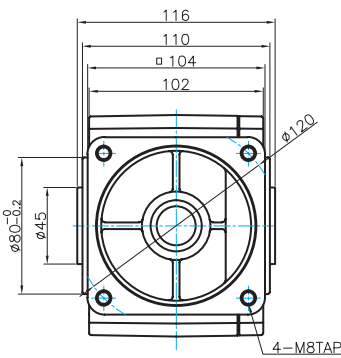
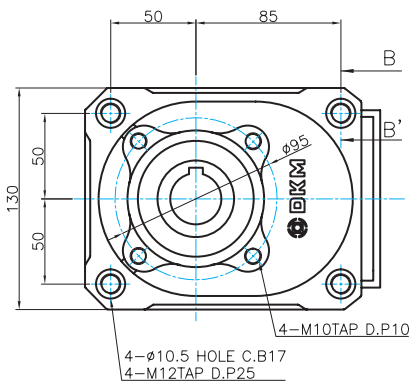

- Gear Ratio 1/80 ~ 1/240

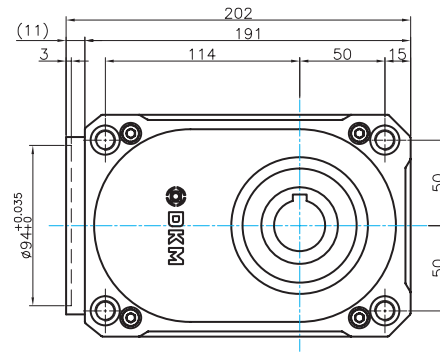
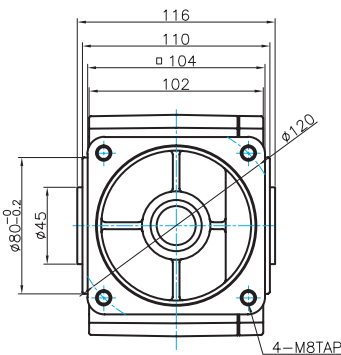
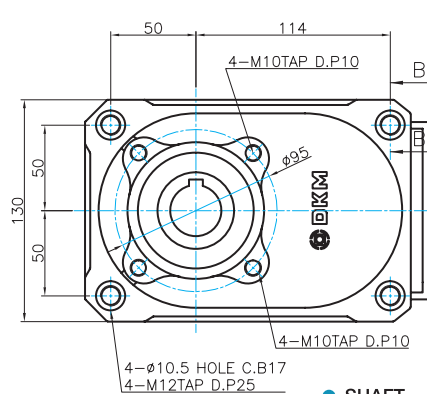

WEIGHT

Model	WEIGHT(Kg)
10HC15□	5,5
10HC20□~10HC60□	5,6
10HC80□~10HC240□	6,4

SHAFT

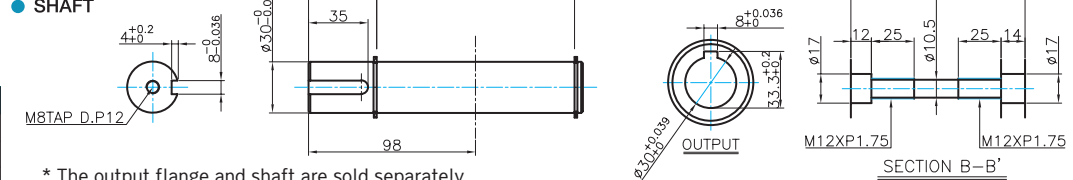

* The output flange and shaft are sold separately

Inter-decimal Gearbox

Frame Size 80mm Model : 8XD10 □ □ **Frame Size 90mm Model : 9XD10** □ □

* Enter the model type of attaching gearbox in the box (□) within the model name.

8XD10□□: GG, GW

9XD10□□: GG, GW, GP, GH, GZ, PP, PW, PH, PZ

- In case of requiring high gear reduction ratio that cannot be generated by single gearbox, please use Inter-decimal gearbox with a general gearbox.
- Please be advised that in this case only the revolution speed of the output shaft will be reduced by 10:1 without increasing of maximum permissible torque.

Dimensions

● Model: 8XD10□□

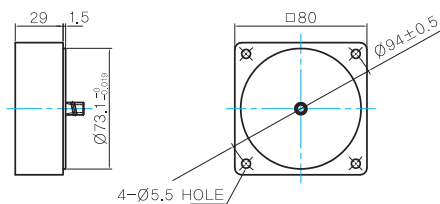

● Model: 9XD10□□

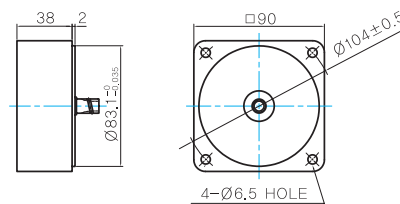

● **WEIGHT**

Model	WEIGHT(Kg)
8XD10□□	0,45
9XD10□□	0,6

How to Attach an Inter-decimal Gearbox?



G type Motor + 9XD10GG + G type Gearbox



G type Motor + 9XD10GP + P type Gearbox



G type Motor + 9XD10GH + H type Gearbox



G type Motor + 9XD10GZ + WH type Gearbox



G type Motor + 9XD10GW + W type Gearbox



P type Motor + 9XD10PW + W type Gearbox



P type Motor + 9XD10PH + H type Gearbox

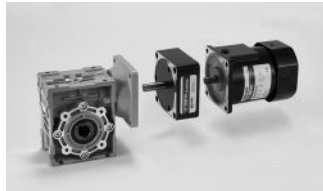

P type Motor + 9XD10PZ + WH type Gearbox



P type Motor + 9XD10PP + P type Gearbox

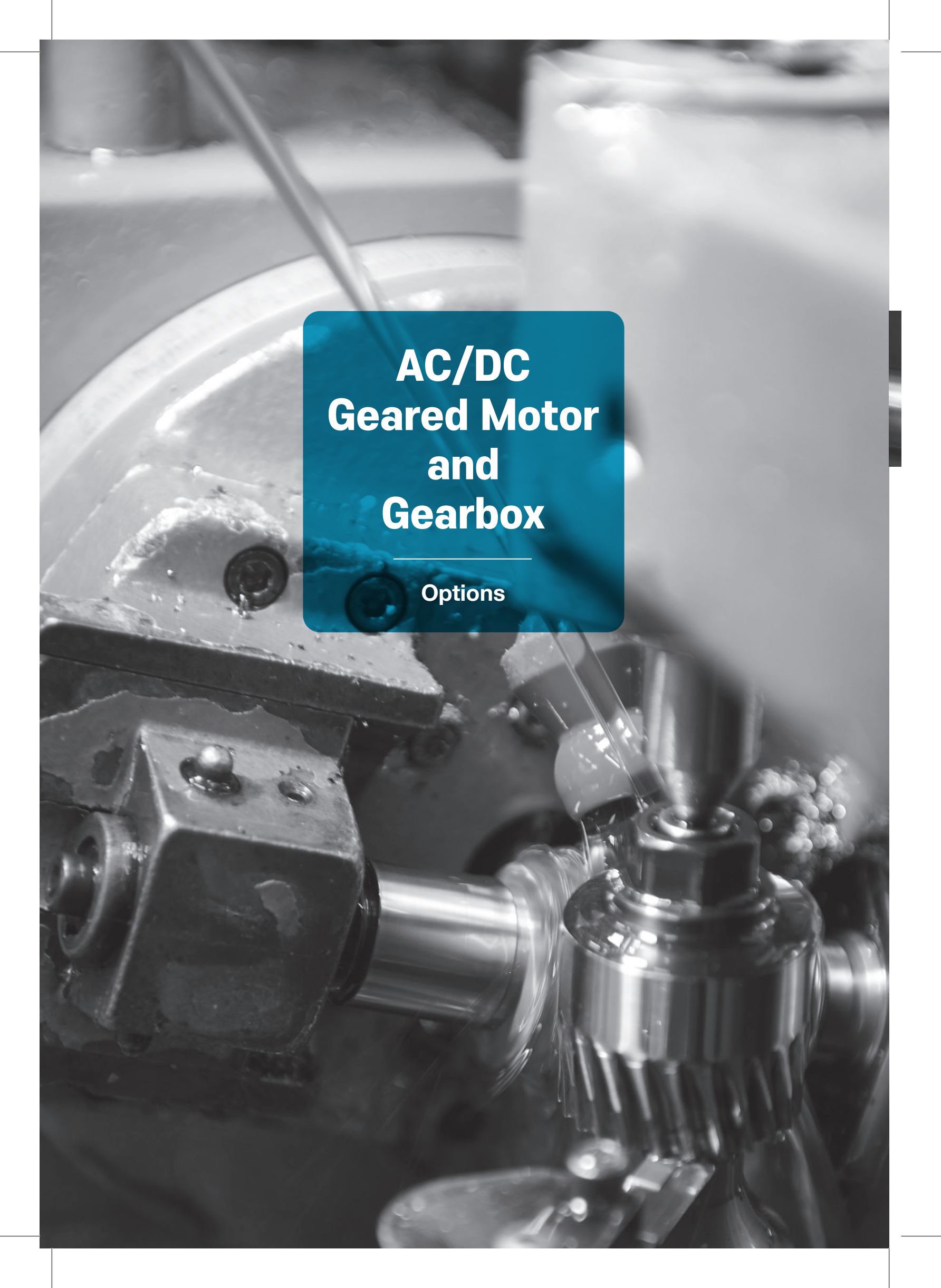

AC/DC Geared Motor and Gearbox

Options



A Information

- A-01 Product Coding System
- A-04 Product Lineup
- A-09 Combination table
- A-13 General Information
- A-17 Terminology
- A-20 Caution for Use

B AC Motors

- B-01 Technical Data of AC Motor
- B-06 Induction Motor
- B-58 2 Pole Motor
- B-76 Reversible Motor
- B-112 Brake Motor
- B-162 Clutch & Brake Motor
- B-178 Torque Motor
- B-206 Speed Control System
 - B-209 Speed Controller FX3000
 - B-213 Speed Controller DX3000
 - B-217 Speed Controller DSA
 - B-219 Speed Controller DSKM
 - B-224 Speed Control Induction Motor
 - B-258 Speed Control Reversible Motor
 - B-288 Speed Control Brake Motor
 - B-322 Speed Control Clutch & Brake Motor
- B-336 DSY Series

C DC Motors

- C-01 Technical Data of DC Motor
- C-04 DC Motor
- C-20 Speed Controller DSD-90

D Gearboxes

- D-01 Technical Data of Gearbox
- D-07 Parallel Gearbox
- D-13 Right-Angle Gearbox
- D-18 Inter-decimal Gearbox

E Options

- E-01 Mounting Bracket
- E-03 Extension Cable
- E-04 Output Flange / Output Shaft

E Options

Mounting Bracket

Mounting Bracket

It enables motor/gearbox to be mounted on installation place.
DKM has mounting brackets of frame size □70/80/90mm for motors and gearboxes.



Product Code

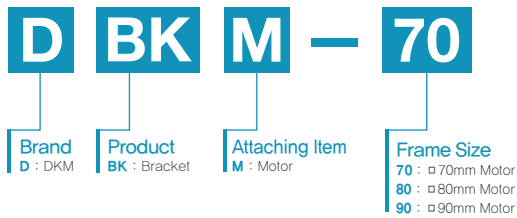

Dimensions

For Frame Size □70mm

● Model: DBKM-70

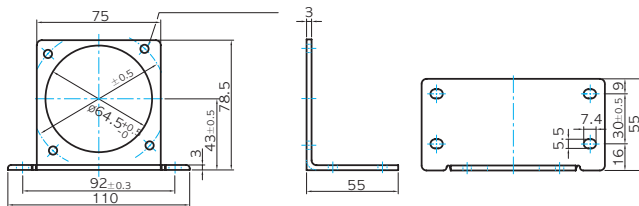

For Frame Size □80mm

● Model: DBKM-80

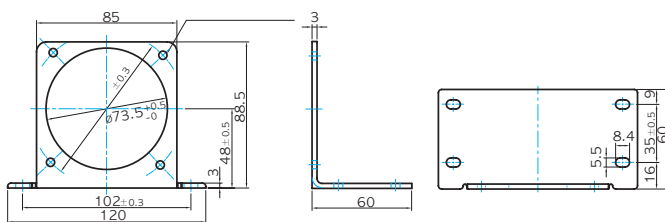

For Frame Size □90mm

● Model: DBKM-90

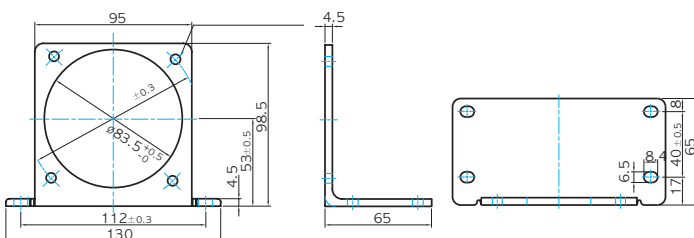

Product Code

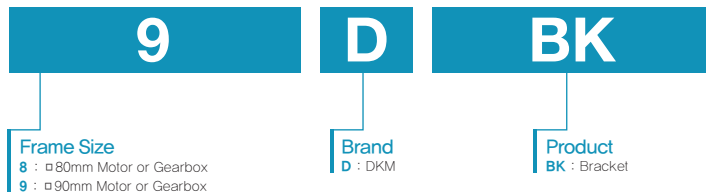

Dimensions

For Frame Size □80mm

● Model: 8DBK

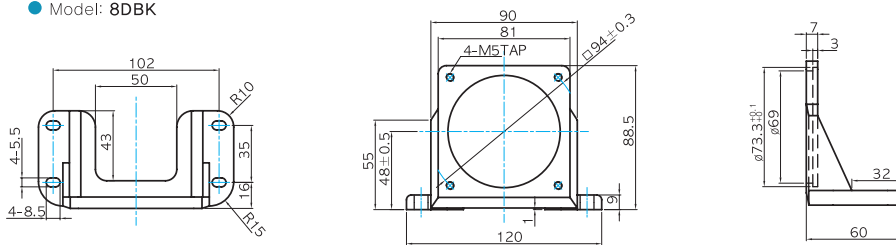

For Frame Size □90mm

● Model: 9DBK

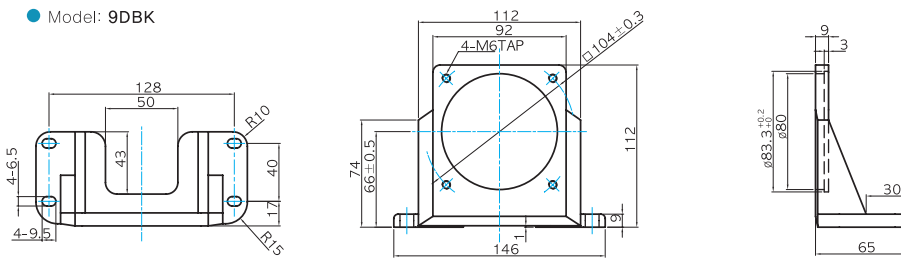

E Options

Extension Cable

Extension Cable

This is for the connection between speed control motors and speed controllers.

The basic length of extension cable is 0.3m. So if longer needed, please order the cable additionally.



Dimension

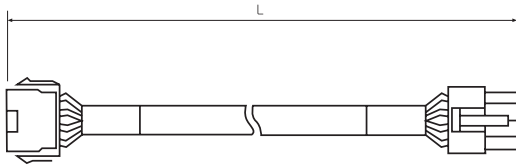

MODEL	Length of cable (L)
DEW-05	0.5m
DEW-10	1.0m
DEW-15	1.5m
DEW-20	2.0m
DEW-30	3.0m
DEW-50	5.0m

Flange(Output / Input)

It is available to fix/install worm hollow type gearboxes by attaching output flange to the gearbox.



Dimensions

● MODEL: WHG030-Fa

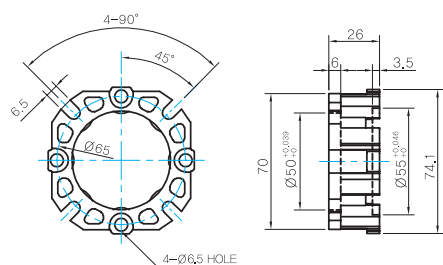

● MODEL: WHG040-Fa

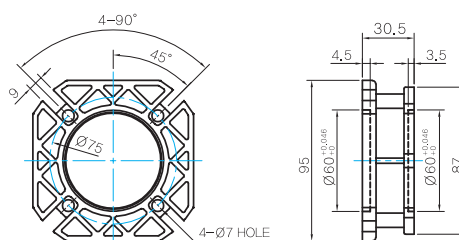

● MODEL: 040-Flange-71B5

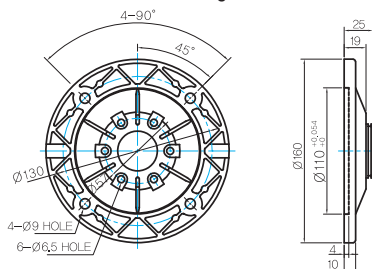

● MODEL: 040-Flange-71B14

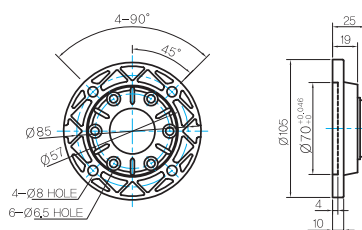

E

Output Flange / Output Shaft

Output Shaft



These are output shafts to be attached to worm hollow type gearboxes.
There are unidirectional output shaft and bi-directional output shaft.

Dimensions

Unidirectional MODEL: 030 SHAFT-S

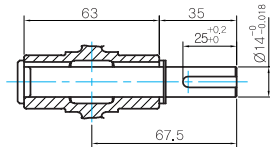

Bi-directional MODEL: 030 SHAFT-D

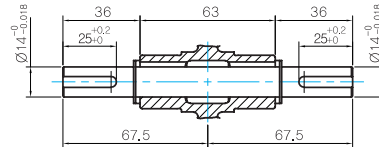

KEY SPEC

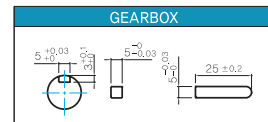

Unidirectional MODEL: 040 SHAFT-S

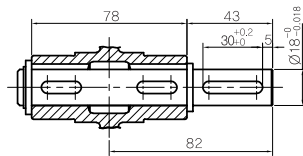

Bi-directional MODEL: 040 SHAFT-D

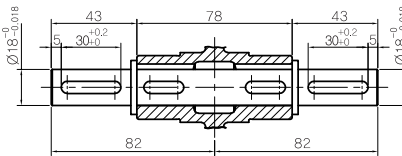

KEY SPEC

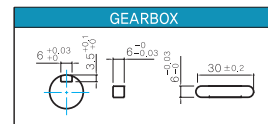

MODEL : 9HC SHAFT-S-□ (Applicable Gearboxes: 9HC□-B)

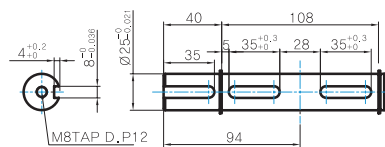

KEY SPEC

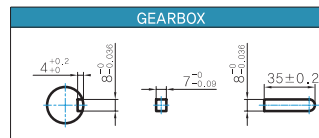

MODEL : 10HC SHAFT-S-□ (Applicable Gearboxes: 10HC□-B)

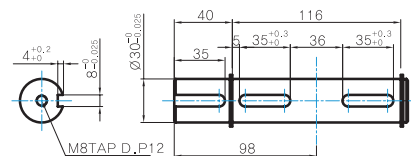

KEY SPEC

